

DECNET  
TECHNICAL SUMMARY  
PDP-11

# Distributed Data Processing Group

**digital**

DECNET  
TECHNICAL SUMMARY  
PDP-11

PRINTED IN U.S.A.

# TABLE OF CONTENTS

## PART I—DECNET

### CHAPTER 1—INTRODUCTION

1.1 DECnet and Networks .....	3
1.2 DECnet—General Description .....	3
1.3 DECnet Functions .....	4
1.4 DECnet Building Blocks .....	4

### CHAPTER 2—DECNET FEATURES

2.1 DECnet Features and Benefits .....	7
2.2 Programmable Calls and Other User Interfaces .....	8
2.3 Down-Line Loading and Remote Program Development and Storage .....	8
2.4 Special Considerations .....	10

### CHAPTER 3—DIGITAL NETWORK ARCHITECTURE

3.1 Structured Design .....	13
3.2 Layered Protocols .....	13
3.3 DDCMP .....	14
3.4 NSP .....	15
3.5 DAP .....	16

### CHAPTER 4—SOFTWARE SYSTEM COMPONENTS

4.1 RSX11 Family .....	17
4.2 RT11 Operating System .....	18
4.3 RSTS/E Timesharing System .....	18

### CHAPTER 5—NETWORK BUILDING BLOCKS

5.1 Network Building Blocks .....	21
5.2 DECcomm 600 .....	21
5.3 Remote Computer Systems .....	22
5.4 IBM Front End .....	23

## PART II—COMMUNICATIONS HARDWARE

### CHAPTER 6—HARDWARE COMPONENTS

6.1 Processors .....	27
6.2 Asynchronous Links .....	28
6.3 PDP-11 Asynchronous Links .....	28
6.4 Configuring Systems with Asynchronous Interfaces .....	29
6.5 Synchronous Links .....	31
6.6 PDP-11 Synchronous Interfaces .....	31
6.7 Configuring Systems with Synchronous Interfaces .....	32
6.8 Synchronous Link Example .....	34
6.9 Parallel Links .....	34
6.10 Distance Considerations .....	34
6.11 Special Adapters .....	35
6.12 DECnet Interconnections .....	35

### CHAPTER 7—MODEM SELECTION GUIDE

7.1 Asynchronous Modems .....	37
7.2 Synchronous Modems .....	37
7.3 Synchronous (Wideband) Modems) .....	37
7.4 Modem Options .....	37

### APPENDIX A—SUMMARY TABLES

A1—DECnet Interconnection Facilities .....	39
A2—Supported DDCMP Modes .....	39
A3—Supported NSP Features .....	39
A4—Supported DAP Features .....	40
A5—DECnet Functions By Host Environment Pairs ..	40
A6—DECnet Interconnectability Matrix .....	41
A7—DECnet Product Reference Table .....	41

# PART I - DECNET

# CHAPTER 1 INTRODUCTION

The intent of this manual is to help you understand "DECnet" (DIGITAL's computer network products) as it relates to the PDP-11. There are sections describing DECnet implementation, sections to assist in the selection of PDP-11 hardware and software, and sections describing network-related products.

Part I is devoted to DECnet implementation and DECnet supported products.

Part II is devoted to DEC products that can be used in a network implementation. These products may or may not be currently supported by DECnet. However, they can be used in the initial phases.

## 1.1 DECNET AND NETWORKS

The term network covers a spectrum of computer configurations. "Terminal Network" sometimes is used to describe a central processor, its peripherals, the terminals that use it, and the links that connect the central processor that is linked to stations having card readers and line printers. People use such networks to submit batch jobs via the card reader, and obtain the results on the line printer. Examples: IBM2780 networks: CDC UT-200.

DECnet falls into another category of Computer Networks. Its salient features are:

1. More than one "node" (a CPU and its associated peripherals) is in the net, being connected via communications links.
2. Each node is potentially capable of performing application oriented tasks. This distinguishes DECnets from terminal and remote job entry networks.
3. No master or "host" CPU is required.

This last category can be further subdivided between closely-coupled and loosely-coupled networks. Closely-coupled networks are those with nodes linked via internal data busses or as a unit; changes in architecture are not easily made. Furthermore, closely-coupled networks usually require all nodes to be in close proximity.

In contrast, loosely-coupled networks such as DECnet offer far greater flexibility in terms of network architecture, functionality and geographical location of the nodes. Network communication can be highly integrated into a specialized system that acts as a unit, or it can be limited to occasional transfers of data files, leaving the nodes quite independent. Since DECnet nodes interact over communications links, the nodes can be in the same room, or halfway around the world.

DECnet is a series of software packages that are fully integrated into DIGITAL's major operating systems and allow easy intercomputer communication over com-

munications links. DECnet is a group of tools that may be used to create networks useful in a variety of applications.

## 1.2 DECNET—GENERAL DESCRIPTION

DECnet is the collective name for the set of software products which extend various DIGITAL operating systems so they may be interconnected with each other to form computer networks. The DECnet user can configure a variety of networks, satisfying a variety of constraints, by choosing the appropriate CPU's, line interfaces (and speeds) and operating systems software. Such networks typically fall into one of three classes:

**Communications Networks:** These networks exist to move data from one physical location to another, often distant, location. The data may be file-oriented (as is often the case for remote job entry systems) or line-oriented (as occurs with the concentration of interactive terminal data). Interfaces to common carriers, using both switched and leased-line facilities, are normally a part of such networks. Such networks are often characterized by the concentration of all user applications programs and data bases on one or two large "Host Systems" in the network.

There are a variety of reasons for implementing communications oriented networks. One major motivation for such networks is to reduce communication line costs. Common elements of such a network are data concentrators (which concentrate a number of lines into a single line back to the main site) and communication front-end preprocessors (which relieve a large computer system of chores associated with communications and line usage). Another type of Communications Network is the type which is aimed at faster movement of information and reduction of paper work. For instance, credit verifications and cash transactions are being handled more and more by on-line terminals and computer-to-computer networks.

**Resource-Sharing Networks:** These networks exist to permit the sharing of expensive computer resources among several computer systems. Shared resources can include powerful central-processors, mass storage devices, unit record equipment, and other peripherals. The resource to be shared may be a logical, rather than physical, entity, as in a data base which is stored centrally and made available to other machines in the network. Such networks are often characterized by the concentration of large peripherals, large data bases, and large programs on one or two "Host Systems" in the network, while "Satellite Systems" have smaller peripherals and programs.

**Distributed Computing Networks:** These networks exist to coordinate the activities of several independent

computing systems toward some larger goal. Networks of this nature may have specific geometries (star, ring, hierarchy), but often have no regular arrangement of links and nodes. Such networks are usually built to put computational power close to the users of such power. Distributed Computing networks are usually characterized by a multiplicity of comparably sized computers and applications programs and data bases distributed throughout the network.

In order to satisfy these widely varying constraints, DECnet allows the user to build networks from a range of system and communication components.

DECnet includes a set of network protocols, each of which is designed to fulfill specific functions within the network. Collectively, these protocols are known as the Digital Network Architecture, or DNA. The major protocols, and their functions are:

**Digital Data Communications Message Protocol (DDCMP):** DDCMP handles the link traffic control and error recovery within DECnet. DDCMP has been designed to operate over full and half-duplex facilities, using synchronous, asynchronous, and parallel facilities.

**Network Services Protocol (NSP):** NSP handles network management functions within DECnet, including the routing of messages within any given system.

**Data Access Protocol (DAP):** The Data Access Protocol enables programs on one node of the network to utilize the I/O calls into the DAP standard, and vice-versa. DAP thus allows remote file access, including OPEN, READ, WRITE, CLOSE and DELETE for sequential and random files, and remote device access, for unit record devices.

### 1.3 DECNET FUNCTIONS

Digital Network Architecture (DNA), implemented across a wide range of operating systems and hardware architectures, enables users to build a variety of networks, as previously described. Such networks have some common attributes, and individual systems in the network may have certain system-specific attributes. The common attributes include:

**Inter-program Communication:** Programs on one system can exchange data with programs on other systems in a real-time fashion.

**Inter-system Resource Sharing:** Programs on one system can utilize files and devices physically attached to other systems in the network.

Additionally, many DECnet systems support other features which are useful in the network environment. These include:

**Down-Line System Loading:** Initial core images for other systems in the network may be stored on the local system, and loaded on request into other systems in the network. The remote systems usually require the use of a network bootstrap loader, implemented in read-only memory.

**Down-Line Program Loading:** Programs to be executed on other systems in the network may be stored on the local system, and loaded on request into other systems, under the joint control of the operating systems at both ends of the network. This and the preceding feature simplify the operation of network systems without mass storage devices, by allowing such systems to use remote mass storage devices in a convenient and straightforward manner.

**Down-Line Program Commands:** Programs running on one system in the network may cause program commands to be executed at remote systems in the network. This feature allows remote programs to be started and stopped.

**Inter-System File Transfer:** This facility allows an entire data file to be moved between systems, at either program or operator request.

**Cross-System Support:** This facility allows program development activities to be performed on a system different from the one where the programs will be executed.

**High-Level Language Interface:** This facility allows programs written in compiler languages (FORTRAN, COBOL, BASIC) to access some or all of the network facilities.

A goal for the set of DECnet products has been to provide as general an interconnection mechanism between specific products as possible, limited only by the technology and cost considerations which constrain each individual member of DECnet. These latter constraints make totally general interconnectability impractical.

DECnet permits communications between various Digital Equipment Corporation processors (DEC-system 10's, PDP-8's and PDP-11's) and various operating systems. This manual is mainly devoted to implementation of communications networks using PDP-11 systems. PDP-11 operating systems which will support DECNET include:

RSX11M	RSTS/E
RSX11D	RT11
RSX11S	IAS

### 1.4 NETWORK BUILDING BLOCKS

DECnet allows the implementation of advanced network capabilities—for instance such network functions as: program-to-program communications, task-to-task communications, and device-to-device communications. Many network users may require less advanced links and capabilities or may prefer to move toward a full DECnet implementation in a phase-by-phase approach. For this class of users DIGITAL offers a series of network "building block" systems which can be used in a "Phase I" implementation and can later be upgraded into a more comprehensive DECnet network. These building blocks are summarized below and described in more detail in Chapter 5.

## Building Block Summary

### PDP-11 OPERATING SYSTEMS

RSX-11D	Powerful multi-task, operating system with multi-terminal support.
RSX-11M	Midsized real-time operating system.
RSX-11S	Small satellite or standalone "core only" system.
RT11	Single user operating system.
RSTS/E	Multi-User BASIC Timesharing System

### SYSTEMS WITH FACILITIES FOR COMMUNICATING WITH IBM

RSX11D/2780	RSX11D system with 2780-type communications.
RSX-11M/2780	RSX-11M system with 2780-type communications.
RSTS/E-2780	RSTS/E time-sharing system with 2780-type communications.
RT11/2780	RT11 system with 2780-type communications.

### BUILDING BLOCK HARDWARE

PDP-11 Family Processors

DX11 PDP-11-to-IBM channel interface

DU11, DQ11, DV11 synchronous interfaces

DL11, DJ11, DH11 asynchronous interfaces

In addition to the above building block hardware and software, DIGITAL's Special Systems Group (CSS) can develop special hardware and software. For instance CSS has developed special switches for connecting busses for multiple PDP-11 CPU configurations, PDP-11/CDC channel interfaces, and HASP workstation emulation software.





# CHAPTER 2

## DECNET

### 2.1 DECNET FEATURES AND BENEFITS

The following table summarizes the capabilities of DECNET nodes.

#### Feature

FULLY-INTEGRATED SYSTEM SOFTWARE.

UPWARD COMPATIBLE IMPLEMENTATIONS on PDP-8's, -11's and DECsystem-10.

DEVICE-SHARING: The ability to access remote peripherals.

FILE SHARING: The ability for programs and terminal users to access remote files, provided they satisfy security requirements.

DOWN-LINE LOADING: The ability to transmit an operating system to a remote computer and have it run there.

REMOTE PROGRAM DEVELOPMENT AND STORAGE: The ability to create and debug a program on one computer and run it on another.

EASY-TO-LEARN PROGRAM INTERFACE for MACRO and FORTRAN programs.

INDEPENDENCE OF LINK CHARACTERISTICS, allowing use of same protocol on asynchronous or synchronous serial links and parallel links.

FIXED-PATH ROUTING: The ability to send messages from one node to another through one or more intermediate nodes.

AUTOMATIC ERROR CORRECTION:

MULTIPLEXING/DEMULTIPLEXING: The ability to carry

#### Benefits

Total operating system acts as a unit; network user programs have all standard systems facilities available to them.

Gives a tremendous range of performance that allows easy configuration of the optimal network for each application. The larger implementations on the PDP-11 and DECsystem-10 have added capabilities in terms of number of devices, number of users, and flexibility. However, within the limits of the types of links supported, any network node may be connected to any other one with no modification to system software except possibly re-SYSGEN or re-TASK-BUILD.

This allows (1) users of terminals on one system to access facilities and terminals on another system, (2) programs to share low usage peripherals among systems to reduce costs, and (3) system managers to create development systems for access by small, execute-only computers.

This allows creation of (1) distributed data base support systems, where sensitive data may be stored locally and given limited external access, and (2) data acquisition systems, where the file system is remote and the data gathering computers may be in a "toxic" environment.

This allows the construction of systems where computers need not have mass storage capability (disks or tapes), but are able to run a variety of applications by requesting programs from other computers in the network.  
(SEE DOWN-LINE LOADING).

Applications programmers who need to code network data exchanges need know very little about communications.

Allows flexibility in choosing the most cost-effective link for each application. When a node supports more than one type of link, main memory requirements are reduced, because the same protocol code can support all links on the node.

Gives added flexibility in network design, and may help in reducing common carrier tariffs.

Users can virtually ignore the problems of correct sequencing and error detection and correction previously associated with data communications.

Allows users to take advantage of better price/performance of high-speed links.

on several, distinct conversations over a single communications link.

**TRUE FULL-DUPLEX OPERATION:** the ability to simultaneously send data in both directions on a full-duplex link.

**MULTIPLE MESSAGE ACKNOWLEDGMENT:** The ability to send more than one message before the first message has been acknowledged as correctly received.

**NETWORK EXERCISER PACKAGE:**

Unlike communications software using earlier link protocols, this feature allows total utilization of a full-duplex link, and increased throughput.

Increases throughput and allows efficient use of links, such as those associated with satellite transmissions.

Aids network maintenance and testing applications programs.

---

## 2.2 PROGRAMMABLE CALLS AND OTHER USER INTERFACES

Users can employ the DECnet features at three levels:

1. Down-line loading of programs and/or whole systems under program or operator control.
2. File creation, transfer access and deletion via calls to subroutines.
3. Inter-program communications via calls to system primitives.

Example:

<b>Local Task Code</b>	<b>Remote Task Code</b>
CALL NTCN	CALL NTCN
This call asks to start the "conversation" by requesting creation of a logical link."	This task will be awakened when other task issues call to NTCN.
CALL NTXMT	CALL NTRCV
This sends the first piece of the conversations.	No communication is possible until receive has been issued.
CALL NTRCV	CALL NTXMT
This gets the answer.	
CALL NTDIS	
This ends the conversation.	The system will inform this task.

## 2.3 DOWN-LINE LOADING AND REMOTE PROGRAM DEVELOPMENT AND STORAGE

Down-line loading allows quick re-booting in nodes without mass storage devices. Remote program development is the analogous capability at the program level. With this capability, customers can create memory-only nodes for reduced cost, or for placement in "toxic" environments. At the memory-only node, down-line load is implemented with a read-only memory bootstrap, which operates on special boot messages sent from the host. The host computer has a resident system program to format the messages and operate the boot-mode protocol.

Remote program development allows programmers to write and debug their programs at a central node, and ship the source or load (depending on the host and

satellite operating systems) module for final compilation and/or execution. The load module may be stored at the host for future runs.

## Operator-and Program-callable File Transfer Functions

The file transfer functions allow:

1. Local/remote, remote/local, and remote/remote transfers of whole files. This means the location of all files in the network can be controlled from one place.
2. Local/remote and remote/local, sequential transfer of records (programs only). This means (for example) that small data collection nodes need only enough storage to handle one record at a time.
3. File allocation, creation, and deletion. No interaction with a remote operator is required for standard file operations.
4. Directory creation and deletion. This completes the tools required for creating a distributed data base management system.
5. Transmission of files containing commands for remote monitors.

## System Primitives

The system primitives allow:

1. Creation and destruction of "logical links," DIGITAL's term for distinct conversations between programs.
2. Transmission and reception of data messages between programs. There is no restriction on data exchanged, except that the recommended maximum for a single message is 528 bytes. Provided extra memory is available, longer messages can be transmitted.
3. Interrupt message facility. This facilitates synchronization and allows checkpointing (rollin/rollout) of network programs.

All non-network functions present on the supporting operating systems are still available when the network support features are added. The network features are strictly enhancements, and they are fully integrated with the rest of the system software. No applications programs need to be re-written to run within a network node, unless network extensions to the applications are desired.

MACRO assembler and FORTRAN interfaces are available in all supporting operating systems. Coding network data transfers is almost as simple as coding transfers to and from a disk.

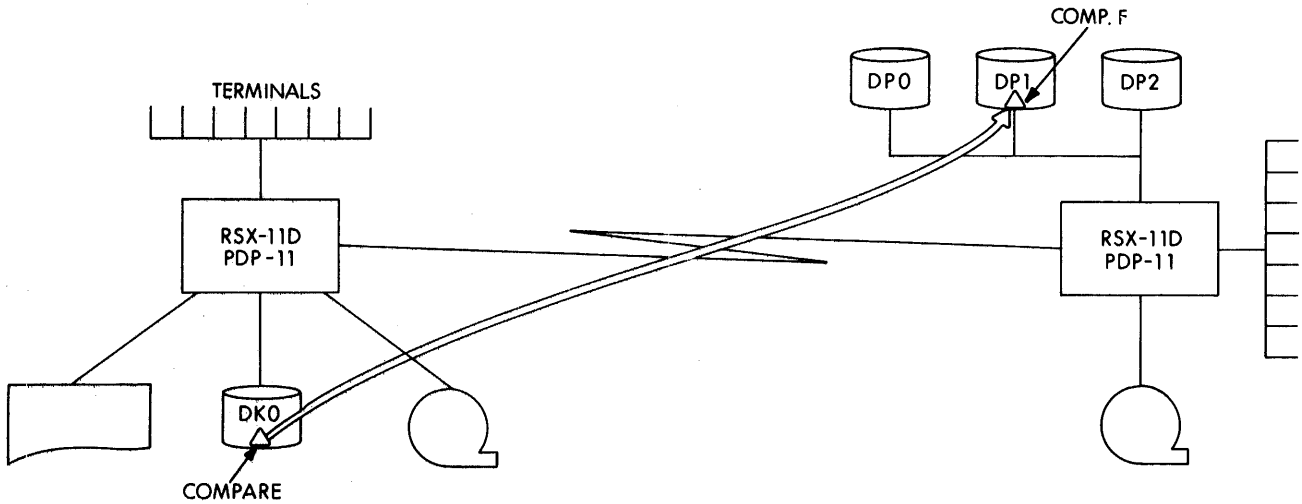
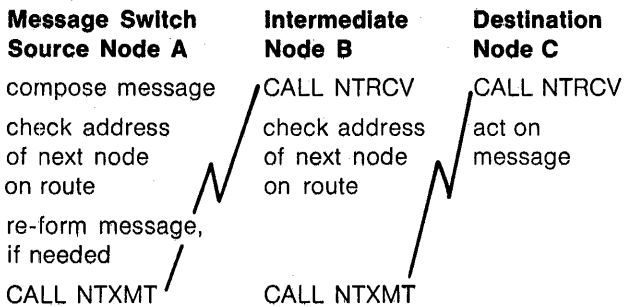

Figure 2-1



**EXAMPLES**

**Remote File Transfer**

In Figure 2-1, an RSX11D system running on a PDP-11 is preparing data for a computational program that runs on another PDP-11 based RSX11D system. The communications link in this case is only a convenience that allows faster turnaround, being preferable to unloading a magnetic tape with the formatted data and physically transporting it to a (possibly) distant computational center.

The communications part of the operation is relatively easy under DECnet, because the input file may be transferred by a single command from one of the terminals. The link is probably a dial-up line, because constant communication is not required.

If the file is transferred via an operator command, the command might look like this:

```
PLE>PDP-11A-DP1:[321,4560]COMP.F=
DK0:[200,200]COMP.PRE
```

The first four characters of this command (PLE>) are the prompting characters supplied by the system program, PLE. The next logical group is terminated by the equal sign (PDP11A-DP1:[321:4567]COMP.F=), and represents the target of the file transfer. PDP11A is the name of the node, and underscore (-) terminates the name. DP1: specifies which device will receive the data, and

[321,4567] specifies the user's area. COMP.F is the name the file will be given. The characters that follow the equal sign specify the source file. No source node name is supplied, so the local node is assumed. DK0:[200,200] specifies the source of the file (RK disk zero, area 200,200), and COMP.PRE is the name of the source file.

**Remote Record Transfer**

Figure 2-2 illustrates a resource-sharing network. As in the previous example, the communications links enhance the capabilities of the outlying systems: they may allow them to support fewer, less expensive peripherals, but in essence, they are only a convenience. The same job could be done without the links, but with greater inconvenience, greater overall cost, and less efficiency for all concerned.

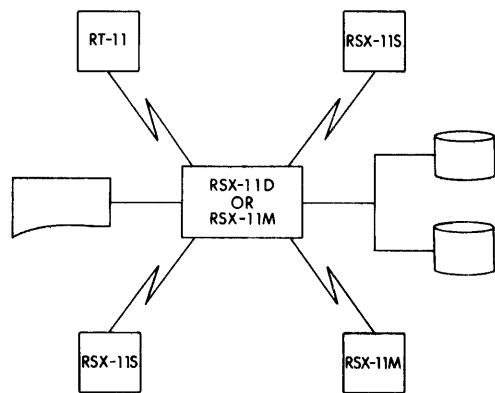

Figure 2-2

Programming required for the communications part of the applications will vary with the way the system is used. If data collected in the outlying systems are stored locally and transferred as a file, no network programming is required—just an operator command. If no local storage is available, or if some real-time coordination between

an outlying system and a task at the central computer is required, however, the system primitives must be used. This is how the code might look:

CALL NFOPN This subroutine opens the file.  
 CALL NFPUT This subroutine stores a single logical record.  
 CALL NFPUT This call stores another one.  
 CALL NFCLS This subroutine closes the file.

No user code or operator intervention is required for the central node, because the internal network system code handles all such transfers.

Note that the programming interface need not be affected by the characteristics of the link (full or half-duplex, synchronous or asynchronous, etc.).

### Complex Inter-program Communication

The lowest level in a certain network may include simple computers (with no mass storage) operating in hostile environments, as well as disk-based computers. Such machines may be used in real-time control of various processes and other on-line functions in the factory. They may have digital and analog acquisition devices and may perform limit checking and control algorithms or directly control and alter the process through the use of digital and analog outputs.

The intermediate level computers provide supervisory control to the assembly line drivers by changing the control parameters and disciplines which they are using. In addition to integrating the assembly line into a single-system that acts to control a single large process, the mid-level machines may also acquire data from various manual entry stations and terminals throughout the factory. The manual entry stations may record material movement, machine utilization, production quantities, employee attendance, inspection results and the like. The terminal may allow real-time inquiry from various managerial levels about order status, equipment use, up-time/down-time, and so on.

The data base, which reflects overall operation of the factory, may be distributed between the mid-level and top-level machines. The latter may be a large-scale PDP-11/70 under RSX-11D. The data base processing can be done by that system, or delegated to the mid-level machines, when appropriate.

In this network, the communications links are fully integrated into the solution of the problem. Applications such as this one may not be solvable by anything but a computer network. The program interface for network communications is likely to be more complicated, only because more is required of the real-time program involved. The actions must be coordinated across machines, so events must be posted, programs must be activated, and data must be passed between nodes. These activities are greatly simplified by the fact that RSX-11M, and -11D are fully upward compatible.

This is how a program might post an event in another machine:

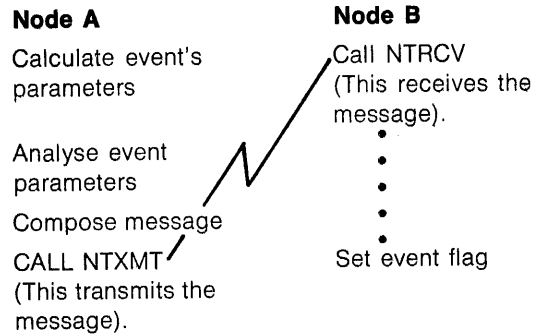

Suppose the process must be changed, and a different program must be loaded into a control system. This is how that would happen:

#### SUPERVISOR NODE

Determine new program required  
 Determine name of task required  
 CALL NTTLD  
 This subroutine transmits the load image from storage to the remote computer.  
 CALL NTCON  
 Request logical connection (conversation) with task just sent over the link.

Note that no coding is required at receiving end.

### 2.4 SPECIAL CONSIDERATIONS

This section is intended to show some limitations of DECnet, and some possible alternatives.

#### Communications With Other Manufacturers' Systems

DECnet specifications will be published, allowing customers with other manufacturers' equipment to code compatible network software. For customers who do not wish to implement DECnet specifications, other software products, such as IBM 2780 packages, are available at extra cost.

#### Adaptive Route-Adaptive

DECnet employs routing techniques that require a fixed structure for the network.

#### Reliability

DECnet provides tools to make "loosely coupled" high-availability systems. These tools, combined with existing DIGITAL options such as multi-port disks and UNIBUS windows, and the high-availability experience of our Computer Special Systems engineers make DIGITAL a major vendor of high-availability systems. This does not, however, mean that DECnet provides instantaneous reliability. Several independent aspects must be considered.

1. Link Reliability—DECnet protocols may not be efficient over extremely noisy links.
2. High-availability Techniques—The designer of a high-availability system must understand the requirements

that redundancy imposes on data storage, file updates, and other critical areas. It is recommended that if such a person does not exist in-house, the customer contact DIGITAL's Computer Special Systems division or a qualified systems house for consultation and assistance.

3. High-reliability Acknowledgement Scheme—DECnet's acknowledgement scheme solves the problem of lost messages in every case except when a node receives a message but "goes down" before processing it. A user-level acknowledgement scheme will ensure full reliability.

### **Transparency**

Network I/O must be explicitly called as such. It is not currently possible to treat I/O devices on a remote node as if they were local. Thus, an application program will typically require some modification if it is to use resources located on other nodes in the net. This approach may appear inconvenient, but it offers many operating advantages. Most of the burden for I/O processing (e.g., buffering and record blocking and deblocking) is placed on the (presumably larger) system at the other end of the link. Additionally, the FORTRAN interface for network facilities allows the user to initiate asynchronous operations, while normal (e.g., local) I/O operations in FORTRAN are service synchronously (that is, the user's program is delayed until the operation is complete). Similarly, many internal operations in remote nodes must be accomplished by a cooperating task in the remote node. For example, in order to post an event in a remote RSX-11D system, the local program must send a message to a remote program with the parameters required to specify the event. That task must then initiate a monitor call to post the event.

### **Multipoint (Multidrop) Communications**

DECnet currently does not support multidrop links (i.e., physical communications links with more than two nodes to a link). However, the DDCMP specification includes provisions for multi-drop implementation.



# CHAPTER 3 DIGITAL NETWORK ARCHITECTURE

## 3.1 STRUCTURED DESIGN

Our design considers the network and its corresponding communication facilities as a number of distinct layers. The entire system of "layers" is called DIGITAL Network Architecture (DNA). Within each layer the functions have been logically separated into modular units. This structured design allows for ease of subsetting and modifications within our network implementations. At each layer the functional modules are independent and may be implemented as either individual tasks or sub-routines within a task or system. This allows creation of nodes with partial functional capability. The layered approach to communications allows modification and/or replacement of a specific protocol without disturbing other layers in the structure.

To make the network as useful as possible there are no specific constraints put on the functional capabilities and their relation to the structure of the net. The physical link protocol DIGITAL Data Communications Message Protocol (DDCMP), allows for point-to-point or multipoint, half or full duplex, or serial (asynchronous or synchronous) or parallel links within the net. The addition of routing through capability at network nodes extends communications to hierarchical and random configurations. These capabilities will allow hierarchical and random configurations. These capabilities will allow line cost reductions in some situations and increased speed and reliability through user-level alternate path routing capability in others.

## 3.2 LAYERED PROTOCOLS

Data to be sent from a user program in one node to a user program in another is enveloped within two or three protocols and passes through various interface layers as parameters required by these protocols are added and subtraced around the user data. The highest layer is the end-to-end or user intertask communications mechanism layer. The next layer must multiplex these many user messages into a single queue or data stream for eventual transmission over a physical data link. This multiplexing usually consists of the addition of header routing information allowing demultiplexing at the receiving end. This data stream is then passed to a link layer protocol concerned with error detection and correct sequencing messages being sent between adjacent nodes. This layer communicates with a driver layer protocol that interfaces with the hardware of the system. The levels in the system may thus be divided as follows:

Dialogue Layer	The conversation created from the messages sent over a logical link into a meaningful exchange between users.
Logical Link Layer	The multiplexing/demultiplexing of the link message stream into

individual message streams for each logical link.

Physical Link Layer	The interface of message packets to/from the hardware layer, concerned with message error detection and recovery, message sequencing and message synchronization over the link.
Hardware Layer	The transmission/reception of the data bits over a physical link, concerned with transmission techniques (synchronous, asynchronous, parallel), character synchronization and modem operation. Provides device independent interface for upper layers.

The dialogue layer depends entirely on the application. It involves both messages and actions taken as a result of the messages. From DECnet's perspective, it may involve several distinct conversations, or "logical links."

The logical link layer creates logical links via the Network Services Protocol (NSP). Network Services Protocol messages and rules support creation of logical links and transfers of user data over those links. The physical link layer implements the link protocol, DIGITAL Data Communications Message Protocol (DDCMP), which ensures proper sequencing of messages, detects and recovers from errors, and controls "ownership" of half-duplex links. The hardware layer is handled by a device driver and interrupt service routine. Its purpose is to exchange data with the hardware interface, handle synchronization, and modem control.

Within DECnet these layers have been related to specific code function, protocols and commands.

Figure 3-1 illustrates the layered approach to network

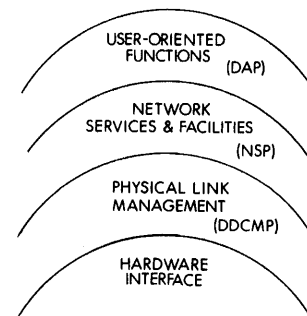

Figure 3-1  
Layered Approach Applied to General Network Design

design, and compares it with typical contemporary operating system design. Layered systems provide:

- Easy debugging of layers
- Clean interfaces
- Easy replacement of layers
- Easy subsetting of layers
- Easy integration with operating systems
- Ability to move hardware/software interface line

Figure 3-2 illustrates the way structured design can be implemented. Figure 3-3 shows data flow through the system. Note how first the routing header, then the link protocol header are added, then the driver transmits the message over the communications link, and finally the headers are subtracted, in reverse order.

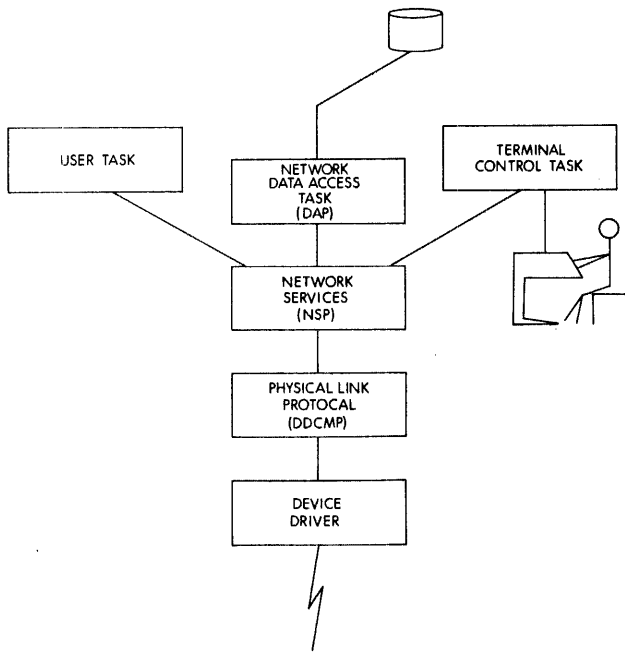

Figure 3-2  
Structured Design

### 3.3 DDCMP, DIGITAL DATA COMMUNICATIONS MESSAGE PROTOCOL

DIGITAL has produced a data link protocol that operates on existing hardware and is implementable on many operating systems.

#### DDCMP, Format

Data is transmitted in variable length blocks called messages, which consist of the data, along with the control and error-detection information needed to check and order this data at the receiving end. All data message headers follow a prescribed format. Besides data messages, there are protocol messages for acknowledgment, initiating message exchange, and error recovery.

There are two parts to a data message—the header, which contains control information, and the data itself. Data messages are numbered so that they may be

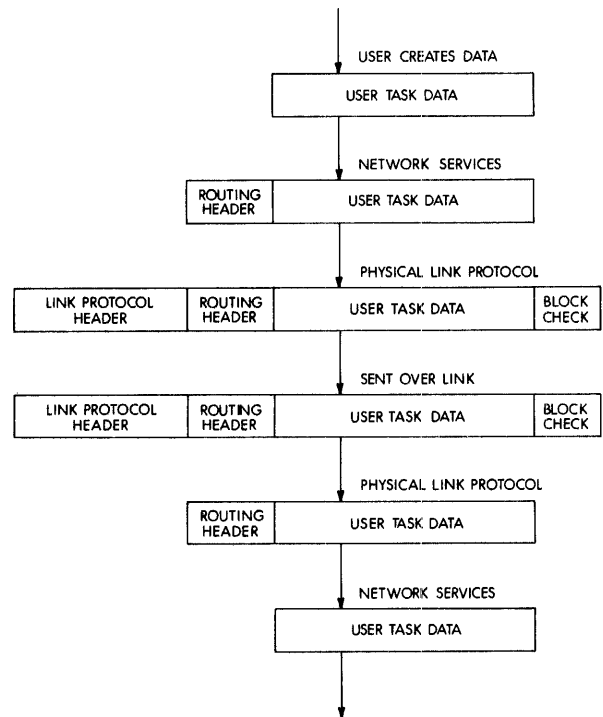

Figure 3-3  
Data Flow Through the System

assembled in the proper sequence at the receiving station. They may arrive out of order due to loss during transmission or duplication by the error recovery mechanism.

The numbering is initialized (usually to zero) by the start message (one or the protocol messages). The number field in the header of each succeeding data message is incremented by one modulo 256 over the preceding data message. That is, the numbers range from zero to 255 and then wrap around.

The receiving station acknowledges correct, in-sequence messages by returning the message number either in the response field of data messages transmitted in the opposite direction or in a separate acknowledgment message (ACK).

Each message does not require a separate acknowledgment. An acknowledgment of one message implies acknowledgment of all preceding ones. This scheme, coupled with capability of acknowledging messages in the header of data messages going in the other direction, allows for efficient use of the data link.

Whenever an error is detected, a negative acknowledgment (NAK) message is returned to the transmitter. The NAK contains the number of the last correctly received message, providing two pieces of information: it acknowledges all messages up through the number given, and implies the need for retransmission for all subsequently sent data messages. Up to 255 unacknowledged messages can be outstanding before an acknowledgment becomes mandatory.



### The Data Message Header

The data message header contains control information, such as a count field that indicates how long the data message is, a message number for sequencing messages and determining loss of a message, and an acknowledgment field that allows message acknowledgment without a separate ACK or NAK message. The header ends with a 16-bit block check used for detection of errors in the header.

### The Data Field and Block Check

The data consists of a stream of bits that must number some multiple of 8. The bit patterns in the data field have no effect on the protocol, so any coding scheme, character size or control characters may be used. If the data field bit count is not an integral multiple of eight, additional zeros must be added to fill out the last 8-bit quantity. The data field is followed by a 16-bit block check for detection of errors in the data.

The block check is a 16-bit cyclic redundancy check that uses the CRC-16 polynomial:

$$x(16)+x(15)+x(2)+1$$

It is the remainder after the division of the data stream by the polynomial. All 48 bits of the header are included in the header block check, and all bits in the data in the data block check.

On the receiving side, the block check itself is included in the computation, giving a zero result when no errors are detected in the block being checked.

### Protocol Messages

There are seven protocol messages plus two BOOT messages for links not under standard DDCMP control. The purpose of each message is described below.

**ACKNOWLEDGE (ACK):** Whenever acknowledgment is required by a protocol message or a data message is not forthcoming to acknowledge earlier data messages received, an ACK is sent.

**NEGATIVE ACKNOWLEDGMENT (NAK):** If a data or protocol message is rejected for any reason listed below, a NAK is returned to the message transmitter from the receiver. The reason for a NAK may be any of the following:

- Header block check error
- Data block check error
- REP message response
- Buffer temporarily unavailable
- Receiver overrun
- Header format error

**REPLY TO MESSAGE NUMBER (REP):** A REP message is sent from the transmitter to the receiver if the transmitter has not heard from the receiver within a pre-determined period and there are unacknowledged messages outstanding. The response to a REP is either an ACK (acknowledging the receipt of the last message sent) or a NAK (acknowledging receipt of some preceding messages and indicating the need for retransmission of succeeding ones.)

**STaRT (STRT):** Begins message exchange. The STRT message is sent by one station to another to initiate communications.

**STart ACKnowledge (STACK):** Transmitted by the receiver to acknowledge receipt of a STRT message.

### Off-Line Mode

DDCMP allows for a special off-line mode that is useful for bootstrapping, dumping, and low-efficiency data transfer for very small nodes (e.g., intelligent terminals or small ROM link controllers). This mode ensures that data will be checked for integrity via the CRC-16, but no acknowledgement scheme is supported by the message formats. Acknowledgement can be handled by a timeout mechanism or by a higher-level protocol enveloped in the data portion of the message.

The message formats in this mode are similar to those used in normal DDCMP messages.

### Efficiency of DDCMP

The efficiency of DDCMP depends on the length of data messages and traffic load on the link. Each DDCMP data message requires ten characters for the message header and block checks. Hence, the greater the message size, the more efficient the protocol becomes.

By including a response field in data messages, there is no need for sending separate acknowledgement messages in high traffic situations. This feature combined with the ability to acknowledge up to 255 messages at a time makes the protocol extremely efficient over long links such as satellite links, and links with very high traffic volume.

Other factors affecting efficiency on multipoint and half-duplex configurations relate to the frequency of selection and quantity of data transmitted per selection interval. These can be traded off based on requirements for throughput and responsiveness. In multipoint systems, the control station does not have to complete error recovery procedures with a given tributary before selecting another one. This means that a single tributary experiencing many errors will not particularly degrade performance of the other stations on the link.

The protocol was designed to operate most efficiently over links with some probability of introducing errors. This includes virtually all links useful in DECNET. For links which are extremely error free or noisy, this protocol may not present the best solution to the communication requirements. For these situations, such techniques as forward error correction and assumed acknowledgement with timeout may prove more efficient for total data throughput on the link.

DDCMP supported modes are summarized in Table A2, Appendix A.

## 3.4 THE NETWORK SERVICES PROTOCOL (NSP)

The logical link protocol layer is called the Network Services Protocol. It is implemented in software by a module called Network Control Services. Network Control Services software routines must (1) allow general

communication between user-level tasks, and (2) do general network supervision.

Inter-task communication breaks down into the following subfunctions:

1. Create for the process layer a "virtual pipe" or "logical link" through which to send and receive messages. Logical links may extend through intermediate nodes.
2. Multiplex and demultiplex process-layer messages on the logical links into physical links.
3. Control traffic through the logical link.
4. Ensure end-to-end delivery with correct sequencing.
5. Allow process interruption.
6. Destroy the logical link.

Network supervision breaks down into the following subfunctions:

1. Inform the various network nodes of new nodes coming up and give their characteristics.
2. Detect node or physical link failure and inform the various network nodes of such failures or other changes in network structure.
3. Route messages through the net.

These are accomplished by defining for all messages a general header that contains control and routing information. User-level data messages also contain a logical address that corresponds to the logical link and a message number that aids in sequencing and error detection.

As in DDCMP, NSP also contains a number of control messages that help request message transmission and do general network supervision. These messages include the following:

1. CONNECT and DISCONNECT—Messages that request creation and destruction of a logical link.
2. LINK STATUS and REQUEST LINK STATUS—Messages that allow request and acknowledgement of data messages.
3. NO-OP (NOP)—A message that allows maintenance work on the lower-layer DDCMP and interface drivers.

4. ECHO and ECHO RETURN—More maintenance messages, this time aimed at the NSP layer.
5. ROUTE-TABLE—Messages that allow dynamic changes in the network structure (announce links coming up or going down or other changes in network structure, and name and describe nodes).

NSP supported features are summarized in Table A3, Appendix A.

### 3.5 DATA ACCESS PROTOCOL (DAP)

The Data Access Protocol (DAP) is a set of message formats and rules used to transfer data between objects in the network, namely, user processes, file storage devices, card readers, line printers, other sequential devices, and user-oriented terminals. Its main function is to make access to remote devices and files convenient.

DAP operates under the Network Services Protocol. Using NSP, a logical link is created between two objects in the system. Once created, the link can be used by the two objects to exchange messages for the purpose of manipulation and transfer of data between the systems. When data exchange is complete, the link is disconnected. The specific DAP functions include:

1. Transfer of file data.
2. Transfer of accounting information.
3. File manipulation.
4. Transfer of file parameters.
5. Pass status over the link. examples:  
File access complete  
End of file  
Illegal user identification  
Illegal account information  
Unsupported file attribute  
Error on Device  
Data error, transfer aborted

DAP is useful for transferring files to line printers, creating new files on remote devices, transferring files from card readers or disks, and deleting files and other file structures.

DAP supported features are summarized in Table A4, Appendix A.

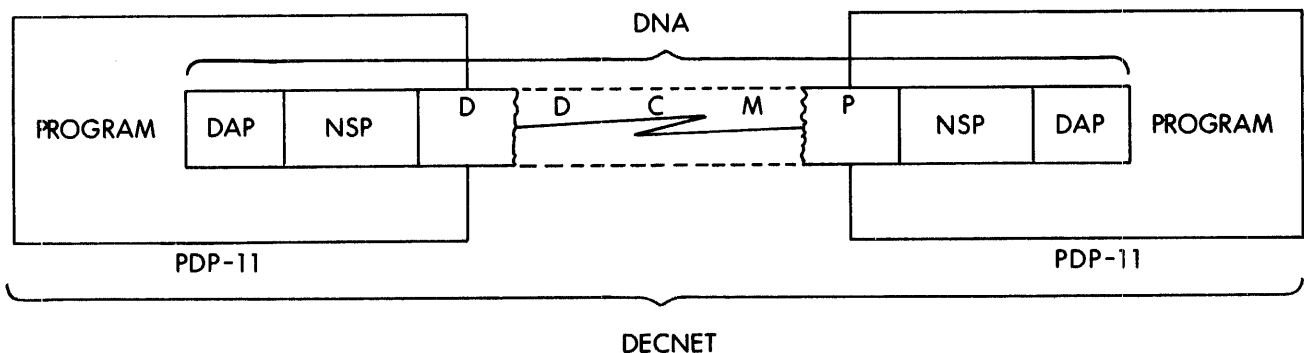

Figure 3-4  
DNA Layers

# CHAPTER 4

## SOFTWARE SYSTEM COMPONENTS

This chapter describes the PDP-11 operating systems that support DECnet: RT-11, RSX11-S, RSX-11M, RSX-11D, RT11 and RSTS/E. These systems are all part of the broad family of DIGITAL operating systems. Each of these systems specializes in one or more areas. RT-11 is a small, flexible system that will operate with or without disk support in single-job or foreground/-background mode. It is well-adapted to program development and high-speed data acquisition. RSX-11S, 'M and 'D make up a family of multi-programmed, real-time operating systems featuring great system power and flexibility.

### 4.1 THE RSX-11 FAMILY

The RSX-11 family is a set of multi-programming real-time systems designed for a wide range of applications where many processes must be monitored and controlled concurrently. They provide easy coupling to on-line processes through a variety of real-time interfaces, and optimum real-time response through dynamic allocation of system resources. They provide straight-forward development of applications programs (tasks) through on-line program development. And, they provide large scale data management capability through an extensive set of file processing techniques.

The RSX-11 family includes three upward compatible systems:

RSX-11S—A small system designed to run stand-alone, or as a satellite computer in a network.

RSX-11M—A midsize system that includes all RSX-11S capabilities plus extensive file management compatibility.

RSX-11D—A large-scale system that includes a batch processor and multi-terminal operation.

Detailed descriptions are included at the end of this section. Real-time operation is based on the interaction of tasks stored within the system and events occurring in the outside world. Examples of events include the arrival of new data from an analog to digital converter, a change in the status of a digital input point, the entry of a command from the system operator. Each event constitutes a potential change in the status of the overall system to which the RSX-11 system must respond.

Programs, or tasks, stored within the system provide the response to real-world events. These tasks may be written in either FORTRAN IV or FORTRAN IV PLUS (supported by RSX-11M and RSX-11D), or COBOL (supported by RSX-11D only) or MACRO assembly language. (RSX-11S does not support program development; that must be done under RSX-11M and the task images then shipped to the RSX-11S system. They can monitor the real-time input data, perform the necessary calculations

and data management, and initiate the response to alter and control on-going processes. There is no limit to the number of tasks that can be stored within an RSX system. Each such task is an independent entity that may be installed, modified, or deleted independently of other tasks.

The basic program unit within RSX-11 is the task. Execution of a task may be initiated by the system operator or by another task.

Once a task has been initiated, its execution and the execution of all other currently active tasks are governed by the RSX-11 Executive based on the occurrence of internal or external events.

### Input/Output

The RSX-11 I/O structure provides a flexible and efficient mechanism for the support of standard PDP-11 peripherals and special purpose devices. This structure provides input/output operations in parallel with task execution, device independence, and easy integration of new device handlers.

### Event Flags and System Traps

The completion of an I/O transfer, or any other event of significance to the system, may be signaled in either of two basic ways: either by the setting of an "Event Flag" or by a system trap. In the case of an "Event Flag," a bit is set which can be tested by the running task or waited for. A system trap interrupts (software interrupt) the running task and forces execution of a separate sub-routine.

### Data Management

In RSX-11M and RSX-11D, file handling facilities permit the defining and accessing of named files, randomly or sequentially, with functions such as space allocation and directory maintenance handled automatically. These functions are performed by the basic file control commands: OPEN, CLOSE, GET, PUT and DELETE.

### Operator Control

The operation of the RSX-11 system may be monitored and controlled by a system operator at any time. The operator may (1) perform initialization functions (such as entering the time and date), (2) request status information (such as a list of installed tasks), and (3) exercise control over system operation (such as by starting and stopping tasks).

### Distinctions among the RSX Family Members

#### RSX-11S

RSX-11S is intended for real-time, multiprogramming applications requiring an inexpensive computer with minimal configuration requirements. The minimal con-

figuration includes 8K of memory; an extra 4K are required of network support. Maximum memory size with optional memory management support is 128K words.

Although RSX-11S can run in stand-alone mode, it is ideally suited for a network environment, because the network can supply the file system and task-loading capabilities that would not be possible in stand-alone mode. Thus, RSX-11S in a network could have all the capabilities of RSX-11M, except that file I/O and task loading will usually be slower, simply because communications links are slower than internal data busses.

FORTRAN and MACRO programs can run under RSX-11S, but the system does not support program assembly or compilation. That, and system generation must be done on an RSX-11M or RSX-11D system.

### **RSX-11M**

RSX-11M is a medium-sized, disk-based operating system that will run on any model of the PDP-11 with at least 24K (10K without network support) words of memory and one disk plus secondary storage that may be disk, DECtape or cassette. As with RSX-11S, memory size can be as great as 128K words with memory management.

In addition to supporting all the features of RSX-11S, RSX-11M supports full disk data management, check-pointing (roll-in/roll-out), and program assembly/compilation.

**FILE STRUCTURE**—The RSX-11M file system is characterized by the following features:

1. On-line file allocation.
2. Comprehensive file protection.
3. Support of both random and sequential-access methods.
4. Support of both fixed and variable-length records.

Four levels of protection are available: System, User, Group and Global. The file organization is independent of the method of access; in other words, all files may be accessed either sequentially or randomly.

**CHECKPOINTING**—RSX-11M provides a checkpointing option (roll-in/roll-out) whereby low-priority tasks can be interrupted by high-priority tasks, copied onto the disk to make memory available to the high-priority task requesting execution, and later resumed from the point of interruption.

**PROGRAM DEVELOPMENT**—RSX-11M supports on-line MACRO assembly and FORTRAN compilation, task building and system generation. Load modules created on an RSX-11M system may be transmitted for execution on RSX-11S nodes.

### **RSX-11D**

RSX-11D is designed for efficient use of large-system resources in an environment with rapidly-changing needs. It supports everything RSX-11M and RSX-11S do, and in addition, dynamic memory allocation, batch processing, shared tasks, and dynamic device handler loading.

**DYNAMIC MEMORY ALLOCATION**—Unlike the other members of the RSX family, RSX-11D can load a task into any available memory. The task building (linkage) process does not include memory assignment, because that is determined at load time.

**CORPORATE STANDARD BATCH**—The RSX-11D batch facility provides the capability to submit requests for a job or jobs to be performed in background mode. Each job can consist of control information and data. The Batch capabilities include:

1. Optimizing FORTRAN
2. ANSI'7 COBOL
3. Shared Tasks
4. Dynamic Loading of Device Handlers

## **4.2 RT-11 F/B OPERATING SYSTEM**

RT-11 is a high performance Foreground/Background operating system that combines powerful computing hardware with user-oriented software. RT-11 is designed for the single user involved in program development and/or real-time applications. It provides fast, simple, on-line access to the full power of any DIGITAL PDP-11 processor with at least 16K words of memory plus mass storage (24K words of memory for DECnet operation).

RT-11's interactive nature and quick response offer give-and-take flexibility plus rapid turnaround. Its queued, real-time I/O and fast throughput take full advantage of the outstanding real-time features of the PDP-11, such as hardware stack processing, multi-level, multi-line priority system, and vectored interrupts.

The RT-11F/B monitor allows two programs to operate at the same time: a foreground program and a background program. The real-time function is accomplished in the foreground which has priority on system resources. Functions which do not have critical response time requirements (e.g., program development) are accomplished in the background, which operates whenever the foreground is not busy. Within their priorities, both foreground and background are complete RT-11 systems with access to all system functions. Although they operate independently, foreground and background can communicate through disk files and/or job communication areas in memory.

If F/B operation is not required, the single-job monitor—which requires less memory and overhead—can be utilized. Should requirements change, upgrading is easily accomplished since programs are completely interchangeable between the single-job monitor and the F/B monitor.

## **4.3 RSTS/E TIMESHARING SYSTEM**

RSTS/E is oriented to interactive rather than batch mode operation. Users interact with the system through a variety of terminals, and through resource-sharing, they have access to and control over system peripherals such as card readers, line printers, paper tape devices, disks and magtape units.

Timesharing users interact with RSTS-E using BASIC-PLUS, a significant extension of Dartmouth BASIC. The

language is easy to learn and work with, yet puts the power of the system at the users fingertips. The immediate mode of operation enables the terminal to be used for simple calculations. Dynamic debugging is faster since programs may be interrupted at any point, checked, corrected, and operation resumed.

Normal timesharing use of RSTS-E consists of typing program text using a keyboard terminal and at the end of the program, typing a RUN command which initiates program execution. A second mode (immediate mode) consists of typing program statements on the keyboard and having them executed immediately. Program statements are identical in either case except that, in immediate mode they are typed without line numbers.

Terminal user may have exclusive use of any peripheral on the system (except the public disk(s) which is a shared device). Not only can all devices be accessed by users at any time, but any device can also be accessed from a BASIC-PLUS program. For example, one user may use the card reader, line printer, magtape and disk for performing a "batch" administrative data processing task; another terminal user may use a mag-tape unit for retrieving or creating a tape file intended for off-line storage; and when the card reader is free, yet another terminal user may read in a punched card file which contains a BASIC program created at an off-line card punch.



# CHAPTER 5

## NETWORK BUILDING BLOCKS

### 5.1 NETWORK BUILDING BLOCKS

Some users may not require a full DECnet capability—Their requirements may only be for remote job entry capability to an IBM system. Other users may wish to move toward a full DECnet implementation in phases, starting with relatively simple building blocks and evolving toward DECnet gradually.

DIGITAL offers a variety of packages which can be used by themselves in communications-oriented applications—or as building blocks toward a full network implementation. The following network building blocks are available:

DECcomm600	a powerful multi-program, multi-terminal system, which can serve as the first step in a network application requiring support of multiple terminals.
Remote Computer Systems	RSX-11M, RSX-11D and RSTS/E systems with facilities for transmitting data to IBM host systems.
Front End System Base	PDP-11-based system with hardware and software for serving as a programmable front-end for IBM systems.

### 5.2 DECCOMM 600

DECcomm 600 is a multi-terminal system designed for maximum effectiveness in transaction processing applications. It is designed to permit a large variety of users, who may be geographically dispersed, simultaneous access to a computer data base. Each user has his own interactive terminal by which he may enter new items into the data-base, inquire of existing information or modify and update the data base.

DECcomm 600 contains RSX-11D plus communications extensions to permit multiple terminal support and clustering of terminals at remote sites; and it can be used to extend DECnet to support of terminals.

The special features of DECcomm 600 which make it highly effective in this environment are:

**TURNKEY COMMUNICATIONS PACKAGE** provides transparent support between the host and both local and remote terminals. Both operator interaction and applications code are unchanged regardless of terminal location.

**COMMUNICATIONS COST SAVINGS** are provided for clusters of remote terminals through the use of concentrators.

**REDUCED COMMUNICATIONS OVERHEAD** in the Host—concentrators communicate with the host on a Direct Memory Access line-by-line basis. All character-by-character terminal handling is done by the concentrators.

This maximizes host transaction processing throughput. **MULTI-TASK OPERATING SYSTEM (RSX-11D)** permits a large number of different transaction application tasks to be processed simultaneously.

**MULTI-USER TASKS** enable many terminals to simultaneously process the same applications task without keeping multiple copies of the task in memory.

**EFFICIENT FILE SYSTEM** provides a data base of over 700 million bytes. Overlapped seeks on multiple disk drives minimize disk access time, the main bottleneck of many transaction processing systems.

**DYNAMIC MEMORY ALLOCATION** and the ability to checkpoint tasks on the disk while they are idle waiting for another input permit maximum efficiency in use of core memory.

**TASK-TO-TASK COMMUNICATIONS** capability enables one transaction application task to activate a number of other tasks if appropriate.

**REMOTE CARD READERS** and Line Printers are supported to enable entry of batch jobs.

DECcomm 600 provides an orderly expansion path from simple to complex applications without requiring applications reprogramming. All applications written for a single processor RSX-11M/RSX-11D system controlling a small number of local terminals can be utilized unchanged on DECcomm 600. The DECcomm 600 package provides turnkey communications software.

When the applications requirements have expanded to where remote data bases, rather than remote terminal clusters, are needed the applications code can be moved out to these sites from the DECcomm 600 host. DECnet, DIGITAL's computer network facility provides the capability for these remote data base sites to communicate with the DECcomm 600 host.

#### Host system

The host system can consist of any valid RSX-11D system (PDP-11/40, PDP-11/45, or PDP-11/70). The PDP-11/40 should appeal to economy minded users, while the advanced features of the PDP-11/70 should be particularly appealing to users for whom high performance is important. Any peripherals supported by RSX-11D can be used; but of particular significance are RP04 disks which can support substantial data bases (88 million bytes per drive).

DECcomm 600 uses version 6A of RSX-11D.

#### Terminal Concentrator

PDP-11/10's or PDP-11/40's functioning as data concentrators, are used to control communications between the host computer and remote terminals. The data concentrators help reduce line costs by accepting messages

from many terminals and transmitting them to the host processor via a single high-speed line.

The concentrator allows:

- Simultaneous use of many interactive terminals
- The clustering of terminals at remote sites to reduce communication costs
- Message assembly and disassembly and character interrupt handling to free up the RSX-11D system
- The use of remote line printers and card readers

A PDP-11 concentrator running under TC/D relieves the RSX-11D host of the processor load inherent in servicing large numbers of character interrupts. Under TC/D the concentrator accepts and stores characters received from terminals until it receives a control character (e.g., carriage return), indicating the end of a complete record. It then transmits the complete record over a synchronous communications link to the host processor at speeds up to 9,600 bits per second.

The communications architecture is simple, point-to-point transmission, making it easy to design a network to suit individual requirements. Transmission between the remote terminals and host computer is full-duplex, enabling simultaneous transmission in both directions. Terminals may be connected directly to the host processor, or over switched or leased common carrier facilities using modems.

Half-duplex transmission (i.e., transmission in either direction but not in both directions simultaneously) is provided as an option. This option permits the use of dial-up connections between the host computer and concentrators and between the concentrators and terminals.

An automatic dialing feature enables the host computer to make its own telephone calls to terminals. Any telephone number known to the applications program can be dialed by the user simply by issuing an I/O statement.

Complex calculations for terminal polling sequences, line loading, and queuing theories are not required; each terminal performs as if it has a direct private line all the way to the host computer.

Concentrator-to-terminal communication is simple asynchronous transmission at speeds up to 9,600 bits per second. Host-to-concentrator communications uses synchronous transmission techniques at speeds up to 9,600 bits per second.

Direct Memory Access (DMA) I/O interfaces are used on the host PDP-11/RSX-11D side of the communications link to handle the character servicing requirements and optimize the transaction processing capability of the host system.

Transmission between the host PDP-11/RSX-11D processor and the remote PDP-11 concentrator(s) makes use of DIGITAL's new message-oriented protocol DDCMP (DIGITAL Data Communications Message Protocol). DDCMP assures the correct sequencing and data integrity of messages transmitted over data channels

subject to noise interference. DDCMP is designed to operate over full- and half-duplex channels in point-to-point and multipoint modes, independent of the bit width and other characteristics of the data channel. It is applicable to multiple computer configurations such as computer networks, host/front-end processors, remote concentrators, and remote entry/exit systems.

### Performance Summary

Total Terminals Per Host:	64 Standard; more with additional software
Total Concentrators Per Host:	4
Total Card Readers:	1 per concentrator
Host-Concentrator	9600 bps maximum
Transmission Speeds:	When 4 TC/D's are used maximum aggregate speed is 19.2K bps with no single line to exceed 9600 bps

### Upgrading DECcomm 600

A DECcomm 600 system can serve as the initial step toward a DECnet implementation.

Upgrades to DECcomm 600 could include:

- A. Upgrading the remote concentrators (PDP-11/10's or PDP-11/40's) to contain RSX-11M software. Communications between the host RSX-11D and the satellite RSX-11M would be via DECnet facilities. The satellite RSX-11M could perform local processing and/or support a local data base.
- B. Connecting multiple DECcomm 600 systems at different sites using DECnet facilities.

### 5.3 REMOTE COMPUTER SYSTEMS

Remote Computer Systems are versatile general-purpose packages which can be used in a wide variety of ways. Remote computer systems have been used for applications requiring powerful local processing and transmission of files to a host IBM system, for applications requiring transmission of magnetic tape data, and for applications requiring local data base facilities.

RSX11/2780	RSX-11M or RSX-11D real time operating systems with 2780 emulation. Transmission can be to and from PDP-11 disk and tape mass storage. 2780 communications can be concurrent with other RSX-11 processing.
RSTS/2780	PDP-11 timesharing system with 2780 emulation. Transmission can be to and from PDP-11 disk and tape mass storage. 2780 communications can be concurrent with other RSTS operations. RSTS terminal users can name files to be transmitted.

A Remote Computer System can:

- Transmit to and receive from mass storage for greater efficiency
- Permit use of unit record equipment simultaneously



with data transmission (RSX11D/2780 and RSTS/2780)

Be an on-the-spot data processing center

Reduce communications costs by processing some data locally and transmitting only essential input to the IBM computer

Support its own data base for quick access

Be upgraded to include DECnet capabilities

The Remote Computer Systems will communicate with an IBM system containing HASP, ASP, POWER, or RJE programs. The IBM system should leave a 2701 data adaptor, a 2703 Transmission Control Unit, a 3704 or 3705 Transmission Controller or a System 370 Model 135 Integrated Communications Adaptor.

The following 2780 features are emulated:

400-byte buffer (maximum transmit or receive block size)

Multiple record feature (up to seven logical records per block can be transmitted or received)

ASCII or EBCDIC—transparency code (console selectable)

Automatic answer

Horizontal printer format control

Extended retry on data-link errors

#### **RSTS/E 2780**

RSTS/E 2780 combines the support for 31 interactive terminals with the ability to manage data bases upwards of 300 million-characters and the ability to transmit files to a host 360 or 370.

With an interactive terminal, each RSTS/E user can request named mass storage to be transmitted over the 2780 link. RSTS/2780 queues all such requests and services them on a first-in, first-out basis. RSTS/2780 places each file received over the link on mass storage under a separate file name. Users can then interrogate RSTS/2780 at any time to determine the names of files queued for transmission.

In addition to the user-oriented "queued" mode, RSTS-2780 can be controlled interactively by the RSTS/E system operator. By typing commands at the console, the operator can indicate files to be transmitted immediately and can dynamically specify the destination of received files.

With RSTS/E, every terminal user can access all system peripherals and resources. Even when RSTS/2780 operations are in progress, RSTS devices and resources continue to be shared by interactive users.

RSTS/E systems can be built around PDP-11/40 or PDP-11/45 computers with up to 248K bytes of memory and disk storage of up to 343-million bytes. Users interact with the system through BASIC-PLUS, an easily learned interactive extension of Dartmouth BASIC language.

#### **RSX-11D/2780**

RSX-11D is the general-purpose multi-tasking operating system for the larger members of the PDP-11 family. It offers task scheduling, task protection, file-structured I/O, program preparation, and utility features normally associated only with much larger computer systems.

RSX-11D is applied to a broad spectrum of scientific computer, laboratory process control, and transaction-processing environments. RSX-11D/2780, running as a task in an RSX-11D system, extends the range of applications of RSX-11D into situations where on-line interface to an IBM computer is required.

Input to RSX-11D can be processed or reduced, and organized into files, and then transmitted to an IBM computer with RSX-11D/2780. The system operator controls RSX-11D/2780 operations via console commands. Input can be transmitted from an optional card reader or from as many as six RSX-11D files by a single console command. Received data can be printed directly on a line printer or routed to RSX-11D mass-storage files for later manipulation and printing. RSX-11D-based Remote Computer.

#### **5.4 IBM FRONT END SYSTEM BASE**

The DECcomm Front-End System Base (FSB) consists of a PDP-11 family computer, an IBM 360/370 interface, and DIGITAL communications software, and is intended as the major element in a 360/370 programmable front-end processing system. It is designed to increase system capability for less cost, to increase application flexibility, and to interface terminals not supported by standard IBM equipment.

With the DECcomm FSB, the user can build a front-end communications system fully compatible with OS/GAM, OS/TCAM, DOS/QTAM, and DOS/BTAM. With the attention interrupt capability, polling operations can be removed from the 360/370 set of tasks. The front-end system interrupts the S/360 when it has data to present.

When designed with modular COMTEX program units, the FSB facilitates the construction of small to large communications systems. A 2848 Emulator Terminal Application Program (ETAP) is provided to make the hardware look like a 2848 display controller to the S/360 or S/370. The compatibility is such that standard IBM diagnostics will run, including the 2848 On-Line Test Program (OLTEP).

#### **Front Ends and Networks**

The Front End System base can be used as an element in a network. However, it is important to note that software (COMTEX) currently supplied with the FSB package is not supported under DECnet. The FSB requires user applications software and "customization" for use in networks.



# PART II COMMUNICATIONS HARDWARE

This section provides information to assist in selecting  
PDP-11:

- communications interfaces
- modems

It is important to note that all the products described in  
this section are not necessarily supported by DECnet.



# CHAPTER 6

## HARDWARE COMPONENTS

### 6.1 PROCESSORS

Any PDP-11 family processors can be used in DECnet applications. The reader is advised to consult other documents in selecting processors—particularly the

PDP-11 Processor Handbooks. The following table provides some guidelines in differentiating PDP-11 processors:

Table 6-1  
Summary of PDP-11 Processors

#### PROCESSOR COMPARISON TABLE

	MINICOMPUTERS			SYSTEM COMPUTERS			
	PDP-11/04	PDP-11/05	PDP-11/10	PDP-11/35	PDP-11/40	PDP-11/45	PDP-11/70
MAIN MARKET	OEM	OEM	End User	OEM	End User	End User and OEM	End User and OEM
MICROPROGRAMMED	yes	yes	yes	yes	yes	yes	yes
STACK PROCESSING	yes	yes	yes	yes	yes	yes	yes
PROGRAMMABLE							
STACK LIMIT	no	no	no	opt	opt	yes	yes
GENERAL REGISTERS	8	8	8	8	8	16	16
REG-TO-REG TRANSFER	2600 nsec	2700 nsec	2700 nsec	900 nsec	900 nsec	300 nsec	300 nsec
HARDWARE FLOATING							
POINT	no	no	no	32-bit (opt)	32-bit (opt)	32, 64-bit (opt)	32, 64-bit (opt)
MAX MEMORY SIZE (BYTES)	56K	56K	56K	248K	248K	248K	2M
MEMORY TYPE	MOS	CORE	CORE	CORE	CORE	BIPOLAR MOS CORE	BIPOLAR (cache) CORE (main)
EFFECTIVE MEMORY SPEED	500 nsec	980 nsec	980 nsec	980 nsec	1000 nsec	300 nsec 500 nsec 1000 nsec	400 nsec
MEMORY PARITY	no	no	no	opt	yes	yes	yes
MEMORY MANAGEMENT	no	no	no	opt	opt	yes	yes
PROCESSING MODES	1	1	1	2 (opt)	2 (opt)	3	3
AUTO HARDWARE INTERRUPTS	yes	yes	yes	yes	yes	yes	yes
AUTO SOFTWARE INTERRUPTS	no	no	no	no	no	yes	yes
POWER FAIL/AUTO RESTART	yes	yes	yes	yes	yes	yes	yes
REAL-TIME CLOCK	yes	yes	yes	opt	opt	yes	yes
PROGRAMMER'S CONSOLE	opt	yes	yes	yes	yes	yes	yes
HARDWARE BOOTSTRAP	yes	opt	opt	opt	opt	yes	yes
SERIAL LINE CONTROLLER	yes	yes	yes	yes	yes	yes	yes
WARRANTY	30-day return to factory	30-day return to factory	90-day on site	30-day return to factory	90-day on site	90-day on site	90-day on site
INSTALLATION, ON-SITE	opt	opt	yes	opt	yes	yes	yes
DIAGNOSTICS MAINTENANCE MANUALS	with first system	with first system	yes	with first system	yes	yes	yes

NO = NOT AVAILABLE

YES = IS STANDARD AND IS INCLUDED

OPT = IS OPTIONALLY AVAILABLE

## 6.2 ASYNCHRONOUS LINKS

An asynchronous interface is used to connect a computer directly to a terminal or to a remote terminal via a modem and a telephone line. In some applications PDP-11's can be connected using asynchronous links.

Asynchronous transmission normally involves the transmission of characters (from a keyboard and to a terminal's printer or CRT) at random intervals. Each character is separated by STOP AND START bits.

In selecting an asynchronous interface, the following must be taken into consideration:

- Type of connection required (direct terminal connection, private phone line, DDD phone line)

- Ability of interface to perform such things as parity checking, insertion and stripping of start/stop bits, buffering, reducing per character interrupts

- Ability of software to modify the interface so as to change line speeds, etc.

Typical features which may or may not be included in an asynchronous interface:

**DATA BITS:** Some asynchronous interfaces can have a variable number of data bits (5, 6, 7, 8, etc.) in order to handle different communications codes (such as ASCII, Baudot, EBCDIC). There are three ways the codes can be set depending on the interface; by inserting or removing jumpers (wires), by manually setting switches in the interface hardware, by software.

**STOP BITS:** Generally one or two stop bits are used. Slow speed transmissions (up to 100 baud) normally use 2 stop bits; faster transmissions (150 baud and higher) normally use one stop bit. Some IBM type terminals (2741's) use one and one half stop bits. Depending on the interface, stop bits can be jumper, switch or program selected.

**BAUD RATE:** Asynchronous interfaces contain a crystal clock which determines the transmission rate. Depending on the type of interface, the baud rate may either be fixed at a single speed when the interface is installed or changed by the program.

**PARITY BIT:** Some applications require some form of checking in order to determine whether the character has been received correctly. In these applications a parity check is performed through the use of a parity bit which is added to each character. Depending on the terminal the parity bit can be:

- not used

- set for odd parity
- set for even parity

Depending on the interface, the parity bit is selected by jumpers, by switches or by the program.

### FULL HALF DUPLEX:

Full-duplex transmission implies simultaneous bidirectional communications; half duplex implies transmission in one direction at a time. Depending on the application and the type of line used half- or full-duplex transmission is used. Some interfaces include provisions for either type of transmission.

### MODEM CONTROL:

Two basic types of modems are available: For connections to private telephone lines, and for connections to the standard dial-up telephone network. When the dial-up telephone network is used a variety of signals must be exchanged between modems (ring, carrier ready, etc.). Some interfaces can control DDD modem signals, while others are only capable of being connected to private line modems.

**INTERRUPTS:** Normally each time a character is received or transmitted an interrupt must be issued by the program. Some interfaces have provisions to place or remove blocks of characters in or out of memory without issuing an interrupt for each character.

## 6.3 PDP-11 ASYNCHRONOUS INTERFACES

The following PDP-11 asynchronous interfaces are available:

### DL11 SINGLE ASYNCHRONOUS LINE INTERFACE

The DL11 is used to connect a PDP-11 to a terminal or a single line. A variety of characteristics can be selected (no. of stop bits, parity, full- or half-duplex, data bits,) but cannot be changed under software control.

### DJ11 16-LINE ASYNCHRONOUS INTERFACE

The DJ11 is used to connect terminals or lines to a PDP-11 in 16 line groups. A wide variety of characteristics can be preselected but cannot be modified under software control. It contains a 64-character "silo" buffer which can be used to reduce interrupt overhead for incoming characters.

### DH11 16-LINE ASYNCHRONOUS INTERFACE

The DH11 is used to connect terminals or lines to a PDP-11 in 16-line groups. A wide variety of characteristics can be selected under program control, so terminals with different characteristics and transmission speeds can access the PDP-11. It contains a 64-character buffer for incoming characters, and has DMA capability for transmitting characters.

## Feature Comparisons

	DL11	DJ11	DH11
Number of Lines Per Interface:	1	16	16
DATA TRANSFERS:	CHARACTER INTERRUPT	SILO (Input)	SILO (Input) NPR (Output)
SPEEDS:	Up to 9600 bps (Fixed)	Up to 9600 (Fixed in 4-line groups)	Up to 9600 Program-Selectable On Each Line
FULL OR HALF DUPLEX:	YES	YES	YES
RECEIVE BUFFER:	DOUBLE-CHARACTER	64-Character SILO	64-Character SILO
SPLIT SPEEDS:	YES	YES	YES
CHARACTER SIZES:	5, 6, 7, 8, bits STRAP-SELECTABLE	5, 6, 7, 8, bits SWITCH-SELECT	5, 6, 7, 8, bits PROGRAM-SELECT
PARITY:	ODD, EVEN, NONE STRAP	ODD, EVEN, NONE SWITCH	ODD, EVEN, NONE PROGRAM
STOP BITS:	1, 1.5, 2 STRAP	1, 1.5, 2 SWITCH	1, 1.5, 2 PROGRAM
20 MAMP	DL11-A, DL11-C	DJ11-AC	DH11-AA + DM11-DA
EIA (LEASED)	DL11-B, DL11-C	DJ11-AA	DH11-AA + DM11-DB or DH11-AD
EIA (DDD)	DL11-E	NO	DH11-AE or DH11-AA plus DM11-BB plus DM11-DC
MIXED 20 MAMP/EIA	—	NO	YES DH11-AA + DM11's
CABLES INCLUDED	YES	NO	DH11-AA + DM11: YES DM11-AE, AD: NO
AUTO ANSWER	YES	YES	YES
AUTO DIAL OPTION	+ DN11	NO	+DN11

## 6.4 CONFIGURING SYSTEMS WITH ASYNCHRONOUS INTERFACES

### DL11

The DL11 can be used to connect the PDP-11 directly

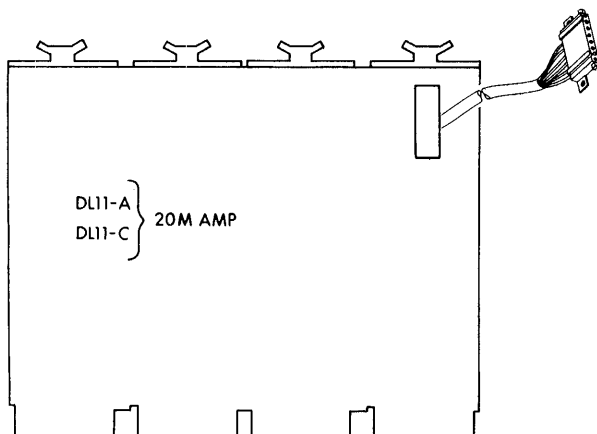

to 20mAmp and EIA terminals or to leased or DDD line modems.

It consists of a single SPC board and a cable. It will mount in any PDP-11 standard SPC slot.

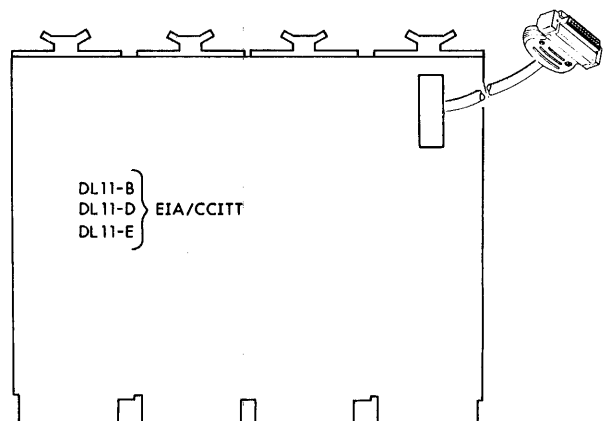

Special Considerations: No more than 32 DL11's should be mounted in the same PDP-11 cabinet.

Cables: Cables are provided. In some instances cables can be extended to greater distances —See DECcomm Hardware Guide for DF11's.

**DJ11**

The DJ11 can be used to connect the PDP-11 directly to 20mAmp or EIA terminals or to leased line modems.

It consists of a system unit and a distribution panel. The system unit will mount in a PDP-11 CPU and the distribution panel requires 5 1/2 inches of rack space (SM PAN).

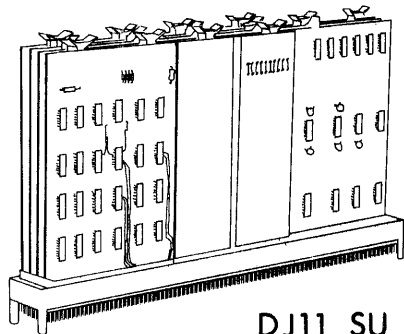

DJ11 SU

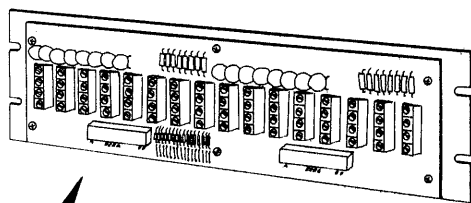

DJ11 SM PAN

MALE EIA/CCITT CONNECTORS OR 4-SCREW TERMINAL STRIPS

CABLES: No cables are provided with the DJ11. For 20mAmp connections the distribution panel has 16 4-screw terminal strips. Cables from terminals can be wired directly to the distribution panel screws.

For EIA/CCITT connections BC05-D-25 cables can be added separately.

**DH11**

The DH11 can be used to connect the PDP-11 directly to 20mAmp and EIA/CCITT terminals and leased line or DDD line modems.

The DH11-AA permits mixed connections to 20mAmp

terminals and modems using the same 16-line DH11. DM11 modules must be added.

The DH11-AE permits connection to 16 EIA terminals or private line modems.

The DH11-AD permits connection to 16 EIA terminals or DDD line modems.

**DH11-AA**

Consists of a double system unit, which mounts in the PDP-11 CPU or mounting box, and a DM11 type distribution panel. DM11 modules must be added to the distribution panel for line connections.

Cables: DM11 modules include cables.

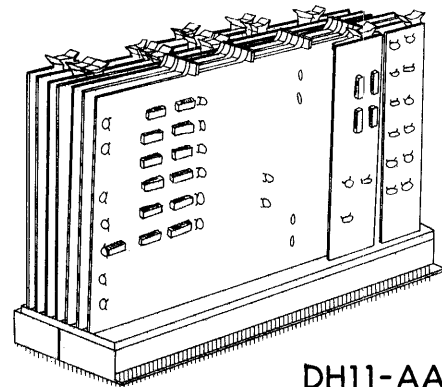

DH11-AA DOUBLE SU

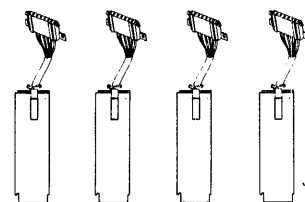

DM11 MODULE SET

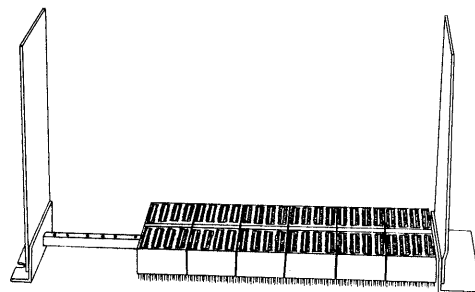

DISTRIBUTION PANEL FOR DM11 MODULES



## DH11-AD, DH11-AE

Consists of a double system unit which mounts in the PDP-11 CPU or mounting box and DJ11-type distribution panel which requires 5 1/4 inches of rack space.

CABLES: DH11-AD and DH11-AE do not include cables (Order BC05D/25).

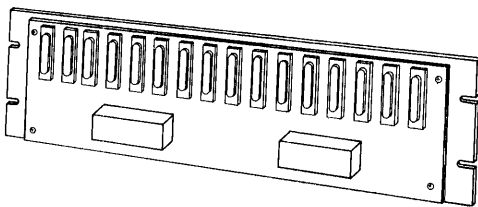
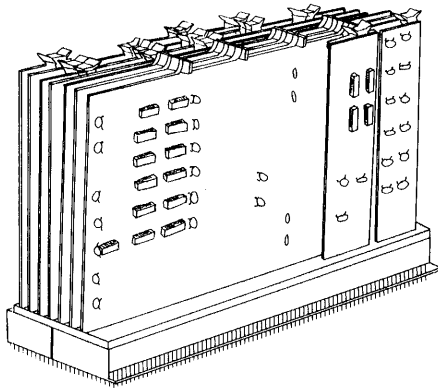

**DJ11-TYPE DISTRIBUTION  
PANEL. REQUIRES BC0D-25  
CABLES.**

## 6.5 SYNCHRONOUS LINKS

Synchronous transmission is the transmission of coded information according to a predetermined synchronization—bits always appear at the same time intervals. When the line is open and there is no data to transmit, some form of "idling" is maintained in order to retain synchronization (or you resynch following the idle period). Synchronous transmission is contrasted with asynchronous transmission in which a continuous stream of bits does not have to be maintained. In asynchronous transmission each character is delimited by start or stop bits, and no data is sent between characters. Synchronous transmissions are generally used when blocks of data messages, streams of characters, etc. are to be transmitted. Computer-to-computer, remote-batch terminal-to-computer, intelligent terminal-to-computer—usually use synchronous communications.

Synchronous transmission is generally more efficient than asynchronous transmission because less bits are used (no start/stop bits for each character), and more

extensive checking techniques are used to recover from possible transmission-induced errors. Synchronous equipment is more expensive but is often used where data integrity or performance is more important than ultimate low cost.

## Selecting a Synchronous Interface

The selection of a synchronous interface depends on various factors:

- transmission speed requirements
- interrupt loading on the processor
- ability to relieve processor load by inserting and removing control characters, performing BCC, etc.
- cost
- mounting space required

## 6.6 PDP-11 SYNCHRONOUS INTERFACES

Three synchronous interfaces are available for use with the PDP-11, the DU11, the DQ11 and the DV11. These are briefly described in the following paragraphs. Complete descriptions are contained in the respective option bulletins.

	SINGLE LINE	MULTIPLE LINE
CHARACTER INTERRUPT	DU11	
DMA	DQ11	DV11

### DU11 Synchronous Interface

The DU11 is a low-cost synchronous interface. It consists of a single small peripheral control board (SPC) and consequently requires very little mounting space. It does not perform NPR data transfers. For CRC/LRC checking, the KG11 is used in conjunction with the DU11 (or software CRC calculation can be done where CPU overhead is not an important consideration).

### DQ11 Synchronous Interface

The DQ11 is a high-performance NPR synchronous interface. It also has options for CRC/LRC checking (DQ11-AB) and special protocol character handling (DQ11-BB). It is capable of handling very high speed transmissions (up to 1 megabaud, depending on message length).

### DV11 Synchronous Preprocessor

The DV11 permits connection of 8 or 16 synchronous lines to a PDP-11. It contains a microprocessor and relieves the PDP-11 of special character handling and BCC generation. It is capable of NPR transfers on all lines on both transmission and reception.

## Feature Comparison

	DU11	DQ11	DV11
CRC/LRC Error Checking	KG11 (Unibus option—1 KG11 can service multiple DU11's)	DQ11-AB—Internal option for DQ11; no load on PDP-11. One DQ11-AB required for each DQ11. (KG11 can also be used)	Internal on all DV11's. All CRC/LRC handled within DV11. No load on PDP-11
Speeds	up to 9600 bps	up to 1 Megabaud	38,000 cps total throughput for all 16 lines (each line up to 9600 bps full duplex)
Mounting	1SPC	DQ11-DA = 1 SU DQ11-AB = 1 SU DQ11-BB mounts in AB	DV11-AA = 2 SU DV11-BA = SM PAN
NPR	No	Yes	Yes All lines
Total Lines Per Interface	1	1	16
Full or Half Duplex	Yes	Yes	Yes
Character-Sizes	5, 6, 7 or 8 bits	up to 16 bits	8 bits
Sync Character Stripping or Insertion	Programmable	Programmable	Programmable
Auto Answering	Yes	Yes	Yes
Parity-checking and generation	Yes in hardware	Yes in hardware	Yes in hardware
Programmable Modem Control	Yes	Yes	Yes
Clock	DFC11 option	DQ11-KA option	Internal for all lines
Sync Character Selection	Programmable	Programmable	Programmable selection of 1 of 2/4-line group
Special Protocol Character Recognition Hardware	No	DQ11-BB option	Internal for all lines
Bell 303 Interface	DF11-G	DQ11-EA	No
Bus Loads	DU11-DA = 1 KG11 = 1	DQ11-DA = 1 DQ11-AB = 1	DV11-AA = 2 DV11-AB = 0

## 6.7 CONFIGURING SYSTEMS WITH SYNCHRONOUS INTERFACES

### Throughput

One of the first considerations in configuring systems with synchronous interfaces is to determine whether the PDP-11 system can handle the data rates of the communications lines. Total throughput is the total data, generally calculated in characters per second, which can be handled by the system. A throughput calculation must take into account:

- maximum aggregate data rate of data being received and/or transmitted
- the number of interrupts generated by the reception or transmission of data
- the amount of CPU intervention required
- length of message being transmitted
- CPU availability
- effect of peripherals
- capability of the operating system

Since throughput calculations are dependent on many variables they vary tremendously from application to application.

At one end of the scale, the capabilities of the PDP-11 operating system must be considered.

At the other end of the scale, one might encounter applications where the user will develop his own software system and dedicate the system to handling communications. In these situations throughput capabilities will possibly be substantially higher.

**Mounting Requirements**

Standard PDP-11 configuration rules apply to the DU11, DQ11 and DV11 as follows:

**DU11**

The DU11 can be used to connect the PDP-11 directly to a single leased or DDD line modem.

It consists of a single SPC board and a cable, and will mount in any standard PDP-11 SPC slot.

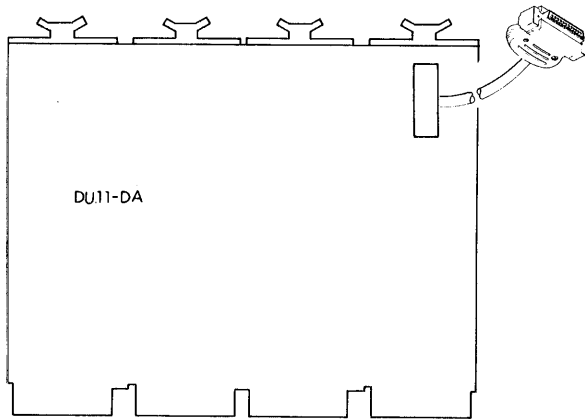

**Special Considerations:** The KG11 is available for use with the DU11 for hardware CRL/CRC calculations.

**Cables:** The DU11-DA includes a 7.6m (25-foot) cable.

**DQ11**

The DQ11 is a high performance synchronous interface for connecting a private DDD line modem to the PDP-11. Several DQ11's can be used as a single PDP-11.

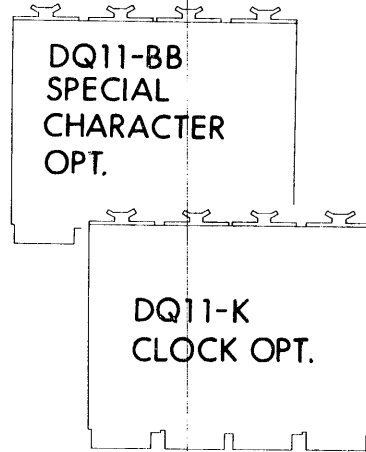
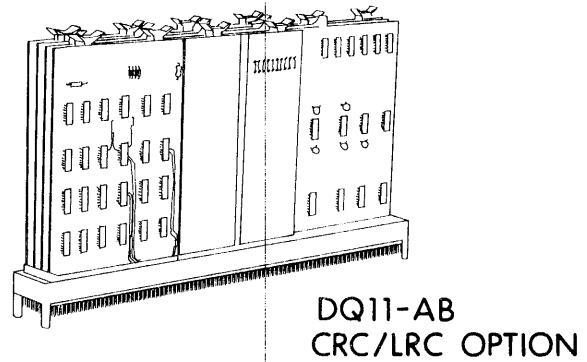
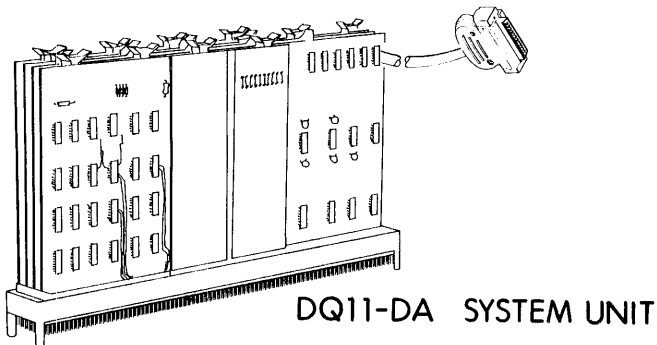

**Special Considerations:** Note options (DQ11-AB, BB, KA) illustrated above. DQ11's can be mounted in any PDP-11 CPU or mounting box except PDP-11/20 and BA11-ES).

**Cables:** The DQ11-DA includes a 7.6m (25-foot) cable.

**DV11**

The DV11 can be used to connect private or DDD line modems to a PDP-11 in 8 or 16 line groups. It consists of a double system unit (DV11-AA) and a distribution panel (DV11-BA).

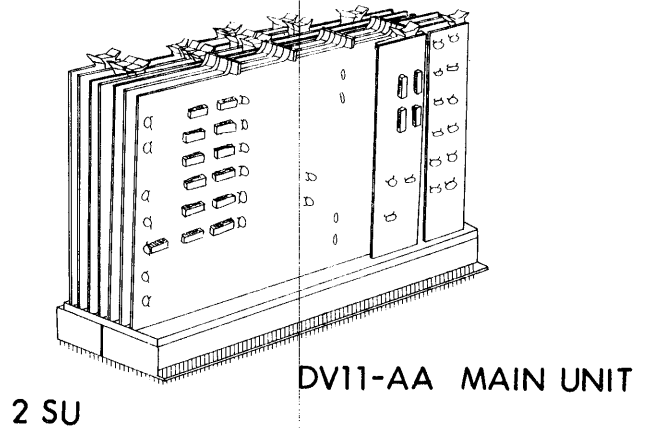

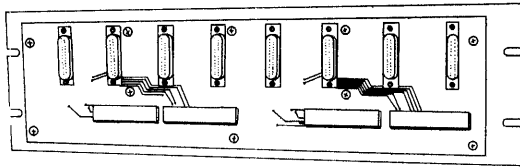

## DV11-BA DISTRIBUTION PANEL

Special Considerations: DV11AA can be mounted in an 11/40, 11/45 or 11/70 CPU or H960 series mounting box.

Cables: Must be ordered separately (BC05-D-75).

### Modem Connections

	Private Lines Modem	DDD Lines Modem
DQ11-DA, DU11-DA	Model (Data Rate) 201A (2000 bps)	Model (Data Rate) 201A (2000 bps)
DV11-AA (+DV11-BA)	201B (2400 bps) 201C (2400 bps)	— 201C (2400 bps)
	208A (4800 bps) 209A (9600 bps)	208B (4800 bps) —
DQ11-EA	303 series (19,200 bps to 50,000 bps)	

### 6.8 SYNCHRONOUS LINK EXAMPLES

#### 1. Connection via Modems

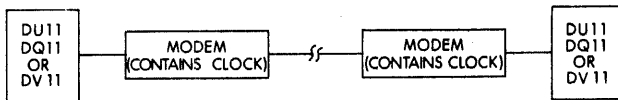

#### 2. Local Connection without Modems

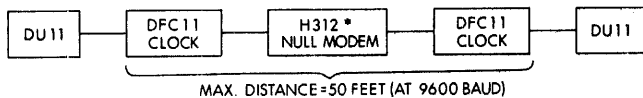

#### 3. Local Connection without Modems (high Speed) (DQ11)

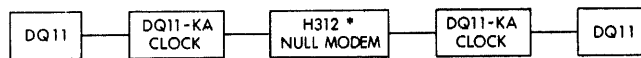

#### 4. Local Connection without Modems (DV11/DU11/DQ11)

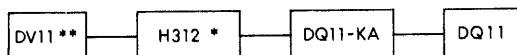
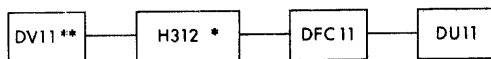
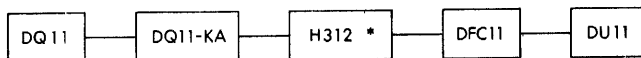

\* Requires wiring modifications  
\*\* Contains internal clock

### 6.9 PARALLEL LINKS

PDP-11's can be connected (UNIBUS-TO-UNIBUS) locally through the use of a DA11 parallel interface.

The DA11-B is a DMA link for high speed parallel data transfers between two PDP-11's using the direct-memory-access (DMA) facilities of each computer, the link transfers either single words or blocks of data from the memory of one machine to the memory of the other. Transfer rates can be as high as 500,000 words per second.

### 6.10 DISTANCE CONSIDERATIONS

#### Parallel Connections (using DA11-B)

The maximum distance is 30 meters (100 feet).

#### Asynchronous Connections

**20mAmp:** Distances can vary considerably depending on the type of terminal used, the type of computer interface and the transmission speeds used.

The following table shows transmission speeds possible at various distances when two PDP-11's are connected using DF11-K adapters.

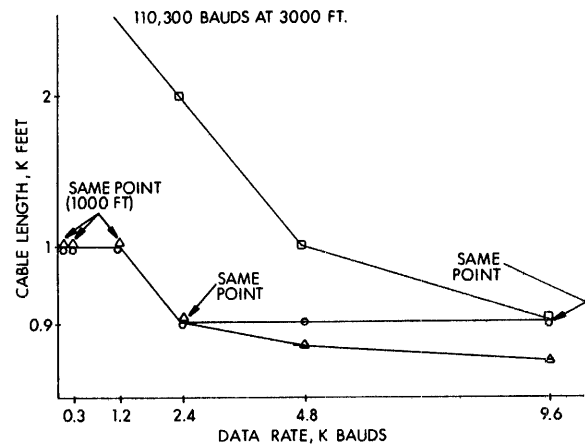

□ Cable is 3 twisted pair, no. 22 AWG stranded, each pair shielded, Belden no. 8777, DEC P/N 91-07723; shields connected to common leads at both ends.

○ Cable is 2 pairs, no. 22 AWG solid inside station wire, DEC P/N 91-05856-04 (Quad).

△ Cable is Belden no. 8777 as above, except shields are Not connected at either end.

Note: Circuit is DF11-K to DF11-K with transmitters active and receivers passive. Distortion limit is 10 per cent.

**EIA/CCITT:** The standard rule when modems are used is that the maximum distance (between the computer and the modem or between the terminal and the modem) cannot exceed 15 meters (50 feet).

However in some instances EIA/CCITT asynchronous interfaces can be used to connect two PDP-11's

together without modems. The following table provides some distance guidelines.

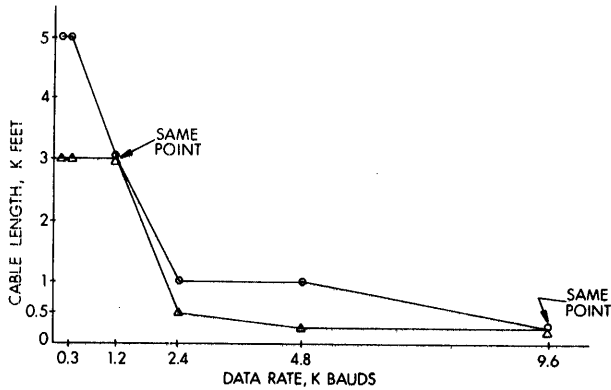

DF11-A active element is M594 module.

△ Cable is 2 pair no. 22 AWG solid inside station wire. DEC P/N 91-5856-04 (Quad).

○ Cable is 3 twisted pair, no. 22 AWG stranded, each pair shielded. Belden no. 8777, DEC P/N 91-07723; shields connected to common (ground).

Notes: Signal tests were between DF11-A's, with distortion limit of 10 percent. Max ground differential is 2 V between ends.

These figures are also applicable to DL11-B, D, and E; DJ11-AA.

\*This table is for a voltage interface for private installations not requiring conformance with EIA standards.

## Synchronous Connections

With Modems: Whenever modems are used the EIA/CCITT 15 meter (50 foot) rule applies.

Without Modems: When two PDP-11's are connected using synchronous interfaces without modems the maximum distance between PDP-11's must not exceed 15 meters (50 feet).

## 6.11 SPECIAL ADAPTERS

A variety of adapters are available for use with the PDP-11 synchronous and asynchronous interfaces.

These include:

DF11-G: Permits connection of DU11-to-Bell 303 series interfaces.

DF11-A: Permits EIA/CCITT connections between PDP-11's.

DF11-F: Provides TTL-to-20mAmp conversion.

DF11-K: Provides TTL-to-20mAmp conversion and permits asynchronous communications between PDP-11's.

H312A: Permits connection of two male type EIA/CCITT connectors (used for local connections between PDP-11's without modems).

DFC11-A: Provides clocking when two PDP-11's are connected locally in synchronous mode without modems.

H319: Permits connection locally between two PDP-11's in asynchronous mode.

## 6.12 DECNET INTERCONNECTIONS

Table A1, Appendix A, summarizes maximum DECnet transmission speeds for each DEC operating system, and Table A2 summarizes interconnectability capabilities (asynchronous, synchronous, parallel) between operating systems.



# CHAPTER 7 MODEM SELECTION GUIDE

## SELECTING MODEMS

In North America, Digital Equipment Corporation tests and warrants communications products with Bell modems. Generally DIGITAL documentation specifies appropriate Bell modems or "their equivalents."

Outside North America, DIGITAL products are generally

warranted to work with the equivalents of Bell modems. However, specific modem equipment depends on the country and the type of equipment in use in that country.

The following Bell modem tables are provided for guideline purposes.

### 7.1 ASYNCHRONOUS MODEMS

		TYPE MODEM RECOMMENDED	
SPEEDS Up to 300 Baud	PDP-11 INTERFACE	PRIVATE LINE	DDD
	DL11, DC11, DJ11, DH11	103A, E, F, G 113A, 113B	103A, E, R
300 to 1800 Baud	DL11, DC11, DJ11, DH11	202C, D, E, R, T	202C, D, E, S

### 7.2 SYNCHRONOUS MODEMS

2000 Bps	DU11, DQ11, DV11	201A, C	201A, C
2400 Bps	DU11, DQ11, DV11	201C	201B, C
4800 Bps	DU11, DQ11, DV11	208B	208A
9600 Bps	DU11, DQ11, DV11	209B*	

### 7.3 SYNCHRONOUS (WIDEBAND) MODEMS

19,200 Bps	DU11/DF11G, DQ11-EA	303B
50,000 Bps	DQ11-EA	303C

\* Permits several lines to be multiplexed. Combinations are:  
1 9600 bps line, 2 4800 bps lines, 4 2400 bps lines.

### 7.4 MODEM OPTIONS

Bell modems offer a variety of optional features depending on the type of modem and specific modem model. The following table indicates some optional features and DEC recommended choice.

OPTIONAL FEATURE	DEC RECOMMENDED
With or Without Auto Calling Unit	Depends on application
Perm. Wired or Key Controlled Auto Answer	Key Controlled
Terminal Responds To Disconnect (Yes/No)	Yes
Terminal Initiates Disconnect (Yes/No)	Yes
Mark Hold/Space Hold	Mark Hold
Answer Mode Indicator Off/On	Off
Answer Control Separate/Combined	Combined
Send/Disconnect Yes/No	Yes

Con of Carrier Disconnect	Yes/No	Yes
Space Disconnect	Yes/No	Yes
EIA/Contact		EIA
Automatic Answer	Yes/No	Yes
New Sync	With/Without	Without
Carrier Control	Continuous/Controlled by RTS	Continuous
Alternate Voice		Depends on customer requirements
Clock Source	Internal/External	Internal
Carrier Control	Continuous/Switched	Switched
Request to Send Control	Continuous/Switched	Switched





# APPENDIX A

## DECNET INTERCONNECTION FACILITIES

SYSTEM	MAXIMUM ASYNCHRONOUS RATE	MAXIMUM SYNCHRONOUS RATE	MAXIMUM PARALLEL RATE
DECSYSTEM-10	—	40.8 KB	—
IAS	—	19.2 KB	—
RSTS/E	—	19.2 KB	—
RSX-11D	—	19.2 KB	125 KW
RSX-11M	9.6 KB	40.8 KB	125 KW
RSX-11S	9.6 KB	40.8 KB	125 KW
RTS-8	9.6 KB	—	—
RT11	9.6 KB	9.6 KB	—

TABLE A1

## SUPPORTED DDCMP MODES FOR DECNET SYSTEMS

SYSTEM	FULL DUPLEX	HALF DUPLEX	POINT TO POINT	MULTIDROP	ASYNCHRONOUS	SYNCHRONOUS	PARALLEL
DECSYSTEM-10	X		X			X	
IAS	X	X	X			X	
RSTS/E	X	X	X			X	
RSX-11D	X	X	X			X	X
RSX-11M	X	X	X		X	X	X
RSX-11S	X	X	X		X	X	X
RTS-8	X		X		X		
RT11	X	X	X		X	X	

TABLE A2

## SUPPORTED NSP FEATURES FOR DECNET SYSTEMS

SYSTEM	LOGICAL LINKS	INTERRUPT FACILITY	MESSAGE ROUTE-THRU	DYNAMIC TOPOLOGY
DECSYSTEM-10	X	X	X	X
IAS	X	X		
RSTS/E	X	X		
RSX-11D	X	X		
RSX-11M	X	X		
RSX-11S	X	X		
RTS-8	X			
RT11	X			

TABLE A3

### SUPPORTED DAP FEATURES FOR DECNET SYSTEMS

SYSTEM	FILE ACCESS		DEVICE ACCESS		VIRTUAL TERMINALS	
	LOCAL	REMOTE	LOCAL	REMOTE	LOCAL	REMOTE
DECSYSTEM-10	X	X	X	X	X	X
IAS	X*	X*	X**	X**		
TSTS/E	X	X	X	X		
RSX-11D	X*	X*	X**	X**		
RSX-11M	X*	X*	X**	X**		
RSX-11S	X*	X*	X**	X**		
RTS-8						
RT11	X	X	X**			

'LOCAL' and 'REMOTE' are defined from the perspective of the application program. Thus, 'LOCAL' DAP support for each feature implies the ability for the application program to access facilities on remote systems. 'REMOTE' DAP support implies the ability to service DAP requests originating elsewhere in the network.

TABLE A4

- \* Operates on sequential files only.
- \*\* Remote access only to device-independent characteristics.

### DECNET FUNCTIONS BY HOST ENVIRONMENT PAIRS

FUNCTION	SYSTEM		SYSTEM	
	from	ALL	to	ALL
INTER-PROGRAM COMMUNICATION		ALL		ALL
INTER-SYSTEM DEVICE SHARING		DEC-10 IAS RSTS/E RSX-11D RSX-11M RSX-11S RT11	with	DEC-10 IAS RSTS/E RSX-11D RSX-11M RSX-11S RT11
INTER-SYSTEM		IAS RSTS/E RSX-11D RSX-11M RT11	with	IAS RSTS/E RSX-11D RSX-11M RSX-11S RT11
DOWN-LINE SYSTEM LOADING	from	DEC-10 RSX-11D RSX-11M IAS	to	DAS85 RSX-11M RSX-11S RT11
DOWN-LINE PROGRAM LOADING	from	RSX-11D RSX-11M IAS	to	RSX-11S
DOWN-LINE PROGRAM COMMANDS	from	RSX-11D RSX-11M RSX-11S IAS	to	RSX-11D RSX-11M RSX-11S IAS

INTER-SYSTEM  
FILE TRANSFER

DEC-10  
IAS  
RSTS/E  
from RSX-11D  
RSX-11M  
RSX-11S  
RT11

DEC-10  
IAS  
RSTS/E  
to RSX-11D  
RSX-11M  
RSX-11S  
RT11

CROSS SYSTEM  
SUPPORT

from RSX-11M

to RSX-11S

TABLE A5

**DECNET INTERCONNECTABILITY MATRIX**

DEC-10	IAS	RSTS/E	RSX-11D	RSX-11M	RSX-11S	RTS-8	RT11
DEC-10	S 40.8						
IAS	S 19.2	S 19.2					
RSTS/E	S 19.2	S 19.2	S 19.2				
RSX-11D	S 19.2	S 19.2	S 19.2	S 19.2			
RSX-11M	S 40.8	S 19.2	S 19.2	S 19.2 P 125	S 40.8 A 9.6 P 125		
RSX-11S	S 40.8	S 19.2	S 19.2	S 19.2 P 125	S 40.8 A 9.6 P 125	S 40.8 A 9.6 P 125	
RTS-8	—	—	—	—	A 9.6	A 9.6	A 9.6
RT11	S 9.6	S 9.6	S 9.6	S 9.6 A 9.6	S 9.6 A 9.6	A 9.6	S 9.6 A 9.6

TABLE A6

**DECNET PRODUCT CROSS-REFERENCE**

PRODUCT	HOST EXECUTIVE	SPD REFERENCE*	SOFTWARE CODE**
DECNET-10	TOPS-10	8.60.0	
DECNET/IAS	IAS	10.71.0	QR680
DECNET/E	RSTS/E	10.73.0	QP690
DECNET-11D	RSX-11D	10.70.0	QP680
DECNET-11M	RSX-11M	10.75.0	QJ680
DECNET-11S	RSX-11S	10.74.0	QJ690
DECNET/RTS	RTS-8	6. 1.0	QF680
DECNET/RT	RT11	10.72.0	QJ685

TABLE A7

\* Software Product Descriptions summarize the capabilities, features and required hardware for each software package.  
\*\* Software Code is the ordering number for the software package.